

ITC 100



# HAND HELD DMM

# OPERATOR'S

# MANUAL

**P69.23**

HYS004227

CONTENTS	PAGE
1. SAFETY INFORMATION .....	1
1.1 PRELIMINARY .....	1
1.2 DURING USE .....	2
1.3 SYMBOLS .....	3
1.4 MAINTENANCE .....	4
2. DESCRIPTION .....	5
3. OPERATING INSTRUCTION .....	9
3.1 MEASURING VOLTAGE .....	9
3.2 MEASURING CURRENT .....	9
3.3 MEASURING FREQUENCY .....	10
3.4 MEASURING RESISTANCE .....	11

### 1. SAFETY INFORMATIONS

This multimeter has been designed according to IEC-1010 concerning electronic measuring instruments with an overvoltage category (CAT II) and pollution 2. Follow all safety and operating instructions to ensure that the meter is used safely and is kept in good operating condition.





#### 1.1 PRELIMINARY

- \* When using this meter, the user must observe all normal safety rules concerning:
  - Protection against the dangers of electronic current.
  - Protection of the meter against misuse.
- \* Full compliance with safety standards can be guaranteed only if used with test leads supplied. If necessary, they must be replaced with the same model or same electronic ratings. Measuring leads must be in good condition.

— 1 —

- \* Never perform capacitance measurements unless the capacitor to be measured has been discharged fully.
- \* Always be careful when working with voltage above 60V dc or 30V ac rms. Keep fingers behind the probe barriers while measuring.

#### 1.3 SYMBOLS

-  Important safety information, refer to the operating manual.
-  Dangerous voltage may be present.
-  Earth ground
-  Double insulation (Protection class II)

— 3 —

## 6. BATTERY & FUSE REPLACEMENT

If the sign "  " appears on the LCD display, it indicates that battery should be replaced. Remove screws on the back cover and open the case. Replace the exhausted battery with a new one.

Fuse rarely need replacement and blow almost always as a result of the operator's error. Open the case as mentioned above, and then take the PCB out from the front cover. Replace the blown fuse with same ratings.

### WARNING

Before attempting to open the case, be sure that test leads have been disconnected from measurement circuits to avoid electric shock hazard.

For protection against fire, replace fuse only with specified ratings: F 200mA/250V (quick acting).

— 24 —

## 5. ACCESSORIES

### 5.1 SUPPLIED WITH THE MULTIMETER

Test Leads	Electric Rating 1500V, 10A	MASTECH HYTL - 060
Battery	9V NEDA 1604 or 6F22	
Operating Manual		HYS004227
Holster		HYHT - 060
Capacitance Testing Adapter		HYHA - 060

### 5.2 How to use the holster

The holster is used to protect the meter and to make the measurement more comfortable, it comes with two stands installed together. The figure shows how to use the holster to:

- Support the meter with a standard angle.
- Support the meter with a small angle using the little stand.
- Hang the meter on the wall using the little stand.

— 22 —

3.5 MEASURING CAPACITANCE .....	12
3.6 TESTING DIODE .....	13
3.7 TESTING TRANSISTOR .....	13
3.8 CONTINUITY TEST .....	14
4. SPECIFICATIONS .....	14
5. ACCESSORIES .....	22
5.1 SUPPLIED WITH THE MULTIMETER .....	22
5.2 HOW TO USE THE HOLSTER .....	22
6. BATTERY & FUSE REPLACEMENT .....	24

#### 1.2 DURING USE

- \* Never exceed the protection limit values indicated in specifications for each range of measurement.
- \* When the meter is linked to measurement circuit, do not touch unused terminals.
- \* When the value scale to be measured is unknown beforehand, set the range selector at the highest position.
- \* Before rotating the range selector to change functions, disconnect test leads from the circuit under test.
- \* When carrying out measurements on TV or switching power circuits, always remember that there may be high amplitude voltage pulses at test points which can damage the meter.
- \* Never perform resistance measurements on live circuits.

#### 1.4 MAINTENANCE

- \* Before opening the meter, always disconnect test leads from all sources of electric current.
- \* For continue protection against fire, replace fuse only with the specified voltage and current rating: F 200mA/250V(quick acting).
- \* If any faults or abnormalities are observed, the meter can not be used any more and it has to be checked out.
- \* Never use the meter unless the back cover is in place and fastened fully.
- \* Do not use abrasives or solvents on the meter, use a damp cloth and mild detergent only.

..... 12  
 ..... 13  
 ..... 13  
 ..... 14  
 ..... 14  
 ..... 22  
 ..... 22  
 ..... 22  
 ..... 24

for each range of mea-  
 ed terminals.  
 the range selector at the  
 est leads from the circuit  
 s, always remember that  
 a damage the meter.

Take the little stand off from the back side of the large stand and insert it into holes located up-  
 per on the holster.

d. Hold test leads

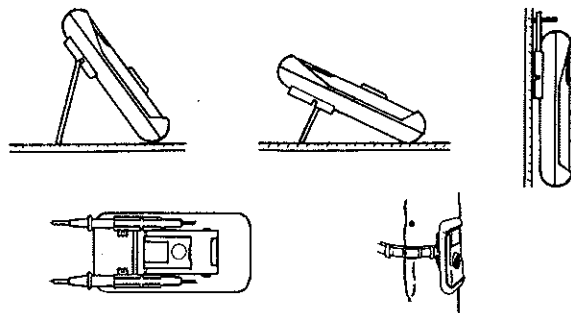

ources of electric current.  
 ified voltage and current

and any more and it has to

fully.  
 and mild detergent only.

#### 4.7 FREQUENCY

Range	Resolution	Accuracy
20kHz	1Hz	$\pm 1.5\%$ of rdg $\pm 5$ digits

Sensitivity: 200mV rms and input no more 10V rms.

#### 4.8 CAPACITANCE

Range	Resolution	Accuracy
2000pF	0.1pF	$\pm 4.0\%$ of rdg $\pm 20$ digits
20nF	1pF	
200nF	10pF	
2 $\mu$ F	0.1nF	
20 $\mu$ F	1nF	

the V  $\Omega$  Hz jack. (The  
 points of the circuit un-  
 ), built-in buzzer will

to 28°C (64° F to 82°

± 3 digits
3 digits
3 digits
3 digits
± 5 digits

Burden Voltage
110mV/mA
15mV/mA
5.0mV/mA
0.03V/A

± 10 digits
-------------

$\Omega$  should be subtracted

### 3.4 MEASURING RESISTANCE

1. Connect the black test lead to the COM jack and the red test lead to the V  $\Omega$  Hz jack. (The polarity of red lead is "+")
2. Set the rotary switch at desired  $\Omega$  position and connect test leads across the resistor under measurement.

#### NOTE:

1. If the resistance being measured exceeds the maximum value of the range selected or the input is not connected, an overrange indication "1" will be displayed.
2. When checking in-circuit resistance, be sure the circuit under test has all power removed and that all capacitors have been discharged fully.
3. For measuring resistance above 1M $\Omega$ , the meter may take a few seconds to get stable reading. This is normal for high resistance measurements.
4. At 200M $\Omega$  range display reading is around 1000 counts when test leads are shorted.

## 3. OPERATING INSTRUCTION

### 3.1 MEASURING VOLTAGE

1. Connect the black test lead to the COM jack and the red test lead to the V  $\Omega$  Hz jack.
2. Set the rotary switch at the desired V  $\overline{\text{—}}$  or V  $\sim$  range position and connect test leads across the source or load under measurement.  
 The polarity of the red lead connection will be indicated along with the voltage value when making DC voltage measurement.
3. When only the figure "1" is displayed, it indicates overrange situation and the higher range has to be selected.

### 3.2 MEASURING CURRENT

1. Connect the black test lead to the COM jack and the red test lead to the mA jack for a maximum of 200mA current. For a maximum of 20A, move the red lead to the A jack.
2. Set the rotary switch at desired A  $\overline{\text{—}}$  or A  $\sim$  range position and connect test leads in series with the load under measurement.

### 2.1 FUNCTION AND RANGE SELECTOR

There are totally 10 functions and 32 ranges provided. A rotary switch is used to select functions as well as ranges.

### 2.2 POWER SWITCH

A push-push switch is used to turn the meter on or off.  
 To extend the battery life, Auto Power-Off function is provided. The meter will be turned off automatically within around 40 minutes. To turn on the meter again, push the power switch to release it and then push it once more.

### 2.3 DATA-HOLD SWITCH

When this switch is active, the meter will hold the last display reading until pushing the switch to release it.

### 2.4 INPUT JACKS

## 2. DESCRIPTION

This meter is a 4 1/2 digit handheld professional measuring instrument, capable of performing following functions:

- DC and AC voltage measurement
- DC and AC current measurement
- Resistance measurement
- Capacitance measurement
- Frequency measurement
- Diode and Transistor test
- Audible continuity test

### 3.8 CONTINUITY TEST

1. Connect the black test lead to the COM jack and the red test lead to the V  $\Omega$  Hz jack. (The polarity of the red lead is positive "+")
2. Set the rotary switch at  $\mathcal{N}$  position and connect test leads across two points of the circuit under testing. If continuity exists (i. e. , resistance less than about 50 $\Omega$  ), built-in buzzer will sound.

### 4. SPECIFICATIONS

Accuracy is specified for a period of one year after calibration and at 18°C to 28°C (64° F to 82° F) with relative humidity to 80% .

Accuracy specifications are given as:

$\pm$  % of readig  $\pm$  number of least significant digits.

— 14 —

### 4.2 DC VOLTAGE

Range	Resolution	Accuracy
200mV	0.01mV	$\pm 0.05\%$ of rdg $\pm 3$ digits
2V	0.1mV	$\pm 0.1\%$ of rdg $\pm 3$ digits
20V	1mV	$\pm 0.1\%$ of rdg $\pm 3$ digits
200V	10mV	$\pm 0.1\%$ of rdg $\pm 3$ digits
1000V	0.1V	$\pm 0.15\%$ of rdg $\pm 5$ digits

Input Impedance: 10M $\Omega$

— 16 —

### 4.4 DC CURRENT

Range	Resolution	Accuracy	Burden Voltage
2mA	0.1 $\mu$ A	$\pm 0.5\%$ of rdg $\pm 5$ digits	110mV/mA
20mA	1 $\mu$ A	$\pm 0.5\%$ of rdg $\pm 5$ digits	15mV/mA
200mA	10 $\mu$ A	$\pm 0.8\%$ of rdg $\pm 5$ digits	5.0mV/mA
10A	1mA	$\pm 2.0\%$ of rdg $\pm 10$ digits	0.03V/A

— 18 —

### 4.6 RESISTANCE

Range	Resolution	Accuracy
200 $\Omega$	0.01 $\Omega$	$\pm 0.5\%$ of rdg $\pm 10$ digits
2k $\Omega$	0.1 $\Omega$	$\pm 0.3\%$ of rdg $\pm 3$ digits
20k $\Omega$	1 $\Omega$	$\pm 0.3\%$ of rdg $\pm 1$ digits
200k $\Omega$	10 $\Omega$	$\pm 0.3\%$ of rdg $\pm 1$ digits
2M $\Omega$	100 $\Omega$	$\pm 0.3\%$ of rdg $\pm 1$ digits
20M $\Omega$	1k $\Omega$	$\pm 0.5\%$ of rdg $\pm 1$ digits
200M $\Omega$	10k $\Omega$	$\pm 5.0\%$ of (rdg - 1000digits) $\pm 10$ digits

Note: On 200M $\Omega$  range, if short input, display will read 10M $\Omega$ , this 10M $\Omega$  should be subtracted from measurement results.



### 3.6 TESTING DIODE

1. Connect the black test lead to the COM jack and the red test lead to the V  $\Omega$  Hz jack. (The polarity of red lead is "+")
2. Set the rotary switch at  $\rightarrow|$  position and connect red lead to the anode, black lead to the cathode of the diode under testing. The meter will show the approx. forward voltage of the diode. If the lead connection is reversed, only figure "1" displayed.

### 3.7 TESTING TRANSISTOR

1. Set the rotary switch at hFE position.
2. Determine whether the transistor to be tested is NPN or PNP type and locate the Emitter, Base and Collector leads. Insert leads of the transistor into proper holes of the transistor testing socket.
3. The meter will show the approx. hFE value at test condition of base current 10 $\mu$ A and Vce 3.2V.

— 13 —

### 4.1 GENERAL

MAXIMUM VOLTAGE BETWEEN

TERMINALS AND EARTH GROUND

FUSE PROTECTION

POWER SUPPLY

DISPLAY

MEASURING METHOD

OVERRANGE INDICATION

POLARITY INDICATION

OPERATING TEMPERATURE

STORAGE TEMPERATURE

LOW BATTERY INDICATION

SIZE (HxWxL)

WEIGHT

1000V dc or 700V rms ac (sine)

mA:F 200mA/250V (A:unfused)

9V battery, Neda 1604 or 6F22

LCD, 19999 counts, updates 2-3/sec

Dual-slope integration A/D converter

"1" figure only on the display

"-" displayed for negative polarity

0°C to 40°C (32°F to 104°F)

-10°C to 50°C (14°F to 122°F)

"" appears on the display

31.5mm x 91mm x 189mm

310g(including battery)

— 15 —

### 4.3 AC VOLTAGE

Range	Resolution	Accuracy	
		50Hz-60Hz	40Hz-1000Hz
2V	0.1mV	$\pm 0.5\%$ of rdg $\pm 10$ digits	$\pm 1.0\%$ of rdg $\pm 10$ digits
20V	1mV	$\pm 0.6\%$ of rdg $\pm 10$ digits	$\pm 1.0\%$ of rdg $\pm 10$ digits
200V	10mV	$\pm 0.6\%$ of rdg $\pm 10$ digits	$\pm 1.0\%$ of rdg $\pm 10$ digits
700V	0.1V	$\pm 0.8\%$ of rdg $\pm 15$ digits	$\pm 1.2\%$ of rdg $\pm 15$ digits

Input Impedance:2M $\Omega$

Frequency Range:40Hz to 1000Hz

Response:Average, calibrated in rms of sine wave

— 17 —

### 4.5 AC CURRENT

Range	Resolution	Accuracy	Burden Voltage
2mA	0.1 $\mu$ A	$\pm 0.8\%$ of rdg $\pm 10$ digits	110mV/mA
20mA	1 $\mu$ A	$\pm 0.8\%$ of rdg $\pm 10$ digits	15mV/mA
200mA	10 $\mu$ A	$\pm 1.2\%$ of rdg $\pm 10$ digits	5.0mV/mA
10A	1mA	$\pm 2.5\%$ of rdg $\pm 10$ digits	0.03V/A

Frequency Range:40Hz to 1000Hz

Response:Average, Calibrated in rms of sine wave