

P50.18

F.I.

# POWER ANALYZER

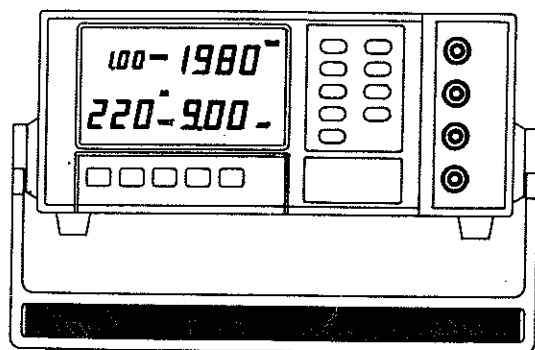

## TABLE OF CONTENTS

1. FEATURES.....	1
2. SPECIFICATIONS.....	1
2-1 General Specifications.....	1
2-2 Electrical Specifications.....	3
3. FRONT PANEL DESCRIPTION.....	8
4. PRECAUTIONS & PREPARATIONS FOR MEASUREMENT.....	10
5. MEASURING PROCEDURE .....	10
5-1 AC Watt/V/A/PF, Hz Measurement .....	11
5-2 AC VA/V/A/PF, Hz Measurement .....	12
5-3 AC Watt Hour ( Whr ) Measurement .....	13
5-4 AC Voltage, Current Measurement .....	13
5-5 DC Voltage, Current Measurement .....	14
5-6 Ohm Measurement.....	15
5-7 AC Watt, VA, Whr measurement, current input cooperate with CT ( current transformer ).....	15
5-8 AC Watt, VA, Whr measurement, current input cooperate with Clamp-On Probe.....	16
5-9 Data Hold.....	17
5-10 Peak Hold.....	17
5-11 Alarm Setting.....	18
6. MAINTENANCE.....	18
6-1 Battery Replacement .....	19
6-2 Cleaning.....	19
7. RS232 PC SERIAL INTERFACE.....	20
8. THE ADDRESS OF AFTER SERVICE CENTER .....	21

## 1. FEATURES

- \* Multi-functions : WATT, VA, Whr, COS  $\theta$  ( Power factor ), ACV, ACA, DCV, DCA, Hz, ohm.
- \* True AC power( Watt ) & apparent power ( VA ) measurement.
- \* True rms display for ACV, ACA.
- \* Supper large LCD, easy to read-out, display the Watt, Power factor, Voltage & Current value at the same time.
- \* Accept different kinds current input signal as direct input, inductive clamp probe or CT ( current transformer ).
- \* Auto range.
- \* Built-in peak hold & data hold function.
- \* Watt & VA measurement with Hi, low alarm setting capability.
- \* RS-232 output interface.
- \* Exclusive custom exclusive design LSI circuit, provides high accuracy, reliability and durability.
- \* Built-in over input indication.
- \* Power supply by batteries or AC to DC adapter.
- \* Built-in low battery indicator .
- \* Durable bench type housing plastic case with carrying handle.

## 2. SPECIFICATIONS

### *2-1 General Specifications*

Display	<ul style="list-style-type: none"><li>* 93 mm x 52 mm large LCD ( Liquid Crystal Display) display.</li><li>* Multi-display unit, show Volt, Ampere, Watt, Power factor or Hz at same time.</li></ul>
---------	--

Measurement	WATT, VA, Whr., Power factor, ACV, ACA, DCV, DCA, Hz, ohm.
Zero Adjustment	<i>Watt :</i> Watt : External adjustment by push button. <i>DCV, ACV, DCA, ACA :</i> Automatic adjustment.
Polarity	Automatic switching, "-" indicates reverse polarity.
Current input mode	Direct input, inductive clamp probe or CT.
Over input Indication	Indication of " - - - - " or " - - - - ."
Data Output	RS232 serial interface.
Sampling Time	<i>W, VA, ACA, ACV, COS <math>\theta</math>, Hz :</i> Approx. 1.5 Sec. <i>DCV, DCA, OHM :</i> Approx. 1 Sec.
Operating Temp.	0 to 50 °C ( 32 to 122 °F ).
Operating Humidity	Less than 80 % R.H..
Power Supply	<i>Battery power :</i> DC 9V, 1.5 V AA (UM-3) battery x 6 PCs. <i>AC power :</i> AC to DC 9V adapter ( 500 mA ), optional.
Power Consumption	<i>Battery power :</i> Approx. DC 30 mA
Dimension	280 x 210 x 90 mm ( 11.0 x 8.3 x 3.5 inch ).
Weight	Approx. 1.6 Kg ( 3.52 LB ).
Standard Accessories	Test lead ( red & black )..... 1 pair. Instruction Manual..... 1 PC.

## 2-2 Electrical Specifications ( 23 ± 5 °C )

**Watt (AC, true power),  
current mode from direct input**

Range	Resolution	Accuracy
6,000 Watt	1 Watt	± ( 1.5% + 5 d )

\*Accuracy are specified under the following conditions :

- a) AC input current is  $\geq 0.4$  ACA &  $\leq 10$  ACA.
- b) AC input voltage is within  $110\text{ V} \pm 15\%$  and  $220\text{ V} \pm 15\%$ .
- c) ACA, ACV input signal is sine wave, 50/60 Hz.
- d) Power factor  $\geq 0.8$ .

\*ACA, ACV frequency response is from 40 to 400 Hz.

\*Max. volt & current input signal value :

Volt input : Max. AC 600V, Current input : Max. AC 10 A

**Watt (AC, true power),  
current input cooperate with inductive probe or CT**

Range	Resolution
9,999 Watt	1 Watt
99.99 KW	0.01 KW
999.9 KW	0.1 kW

\*Accuracy will be same as the above " Direct Current Input Mode " but plus the accuracy value of Current Transformer ( CT ) or the accuracy value of Inductive Current Probe.

\* *Input current should obey :*

Inductive Probe –  $\geq 20$  ACA.

CT 100/5 A –  $\geq 8$  ACA.

CT 1000/5 A –  $\geq 80$  ACA.

**VA ( AC, Apparent Power )**  
*current mode from direct input*

Range	Resolution	Accuracy
99.99 VA	0.01 VA	± ( 2 % + 2d )
999.9 VA	0.1 VA	
9,999 VA	1 VA	

\*Accuracy are specified under the following conditions :

- a) AC input current is  $\geq 0.4$  ACA &  $\leq 10$  ACA.
- b) AC input voltage is within  $110\text{ V} \pm 15\%$  and  $220\text{V} \pm 15\%$ .
- c) ACA, ACV input signal is sine wave, 50/60 Hz.

\*ACA, ACV frequency response is from 40 to 400 Hz.

**POWER FACTOR**

*current mode from direct input only*

Range	Resolution	Accuracy
0.01 to 1.00	0.01	± ( 1.5% + 2 d )

\*Accuracy are specified under the following conditions :

- a) AC input current is  $\geq 0.4$  ACA &  $\leq 10$  ACA.
- b) AC input voltage is within  $110\text{ V} \pm 15\%$  and  $220\text{V} \pm 15\%$ .
- c) ACA, ACV input signal is sine wave, 50/60 Hz.

\*Max. volt & current input value :

Volt input : AC 600V, Current input : AC 10A

**AC VOLTAGE ( true rms ),DC VOLTAGE**

Range	Resolution	Accuracy
0.1 V to 299.9 V	0.1 V	DCV : ± ( 1 % + 1d )
300 V to 600 V	1 V	ACV ( ≤ 10 V ) : ± ( 1 % + 7d ) ACV ( 11 V to 100 V ) : ± ( 1 % + 5d ) ACV ( Others ) : ± ( 1 % + 1d )

- \* Auto range.
- \* Max. input voltage : AC 600 V, DC 600 V.
- \* ACV accuracy is test under input signal is sine wave, 50/60 Hz.
- \* ACV frequency response is from 40 to 400 Hz.
- \* ACV is true rms.

**AC CURRENT ( true rms ),DC CURRENT  
*current mode from direct input***

Range	Resolution	Accuracy
0.01 A to 10.00 A	10 mA	ACA : ± (1%+3d) DCA : ± (1%+1d)

- \* Max. input current : AC 10 A, DC 10 A.
- \* ACA accuracy is test under input signal is sine wave, 50/60 Hz.
- \* ACA frequency response is from 40 to 400 Hz.
- \* ACA is true rms.

**AC CURRENT ( true rms ),DC CURRENT  
*current mode from inductive probe***

Range	Resolution
1000 A	1 A

- \* Accuracy : Meter voltage range accuracy plus Inductive Probe's accuracy.
- \* ACA is true rms.

**AC CURRENT***current mode from CT ( current transformer )*

Range	Resolution
CT 100/5A, 0.1 – 200.0 A	0.1 A
CT 1000/5A, 1 – 2000 A	1 A

\* Accuracy : Meter current range accuracy plus  
CT ( current transformer ) accuracy.

\* ACA is true rms.

**Watt Hour***current from direct input*

Range	Resolution
0.001 Whr to 9.999 Whr	0.001 Whr
10.00 Whr to 99.99 Whr	0.01 Whr
100.0 Whr to 999.9 Whr	0.1 Whr
1000 Whr to 9999 Whr	1 Whr
10 K Whr to 99.99 K Whr	10 Whr
100 K Whr to 999.9 K Whr	100 Whr
1000 K Whr to 9999 K Whr	1 K Whr

\* Accuracy & other specification requirement same as  
" Watt " range exactly

**OHMS**

Range	Resolution	Accuracy
9,999 ohm	1 ohm	± ( 1 % + 1d )
19.99 K ohm	10 ohm	

\* Auto range.

\* Overload protection " Max. AC/DC 300 V.



Hz		
Range	Resolution	Accuracy
10.0 Hz to 99.9 Hz.	0.1 Hz	$\pm (1\% + 1d)$
100 Hz to 999 Hz.	1 Hz	
* <i>Auto range.</i>		
* <i>Frequency signal input voltage level should &gt; 6V &amp; <math>\leq</math> 600 V.</i>		

*Remark :*

*The above specification are tested under the environment RF Field Strength less than 3 V/M & frequency less than the 30 MHz only.*

### 3. FRONT PANEL DESCRIPTION

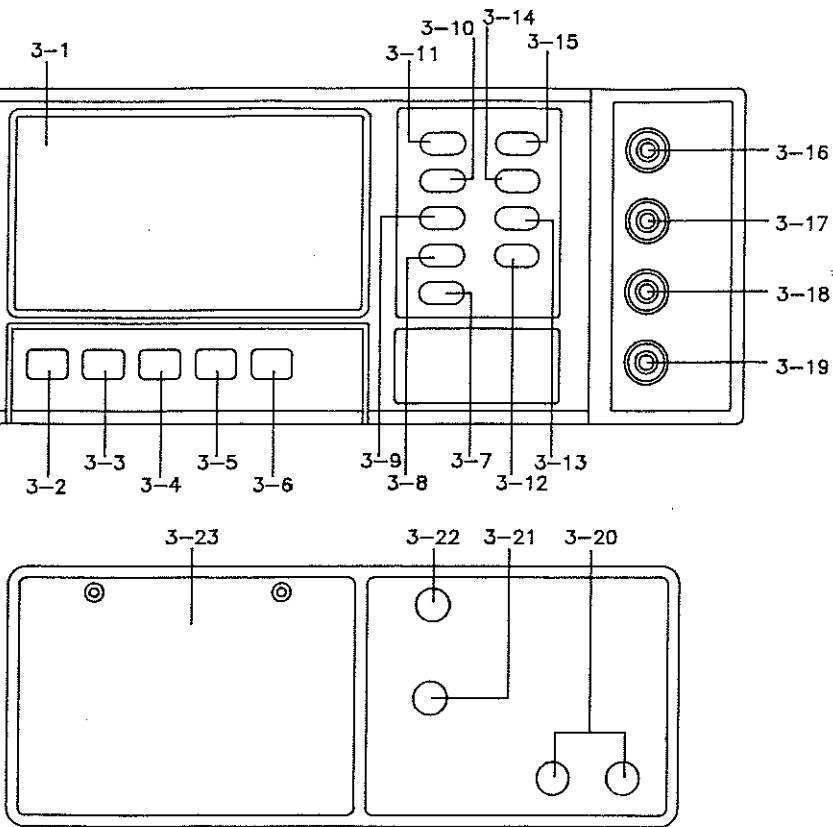

Fig. 1

**Marks :**

On = 1, Off = 0

AC =  $\sim$  , DC =  $\text{---}$

- 3-1 LCD Display
- 3-2 Power Switch
- 3-3 AC V/A/WATT Switch
- 3-4 DC V/A Switch
- 3-5 Ohm Switch
- 3-6 Current In Switch
- 3-7 WATT/VA/Whr Button
- 3-8 WATT Zero Button
- 3-9 COS  $\theta$  ( power factor )/Hz Button
- 3-10 Peak Hold Button
- 3-11 Data Hold Button
- 3-12 Current Mode Button
- 3-13 " ^ " Button ( Alarm Set )
- 3-14 " > " Button ( Alarm Set )
- 3-15 Alarm Set Button
- 3-16 Watt Terminal
- 3-17 V/Ohm Terminal
- 3-18 COM Terminal
- 3-19 Current Terminal
- 3-20 Clamp-On Current Input Terminals
- 3-21 DC 9V Power Adapter Input Socket
- 3-22 RS-232 Output Terminal
- 3-23 Battery Cover/Battery Compartment

#### 4. PRECAUTIONS & PREPARATIONS FOR MEASUREMENT

- 1) Ensure that the batteries is connected correctly to its snap terminal and placed in the battery compartment.
- 2) Select & push the correct Switch & button before marking measurements
- 3) Place the Test Lead into the proper input terminal before marking measurements.
- 4) Remove either of the test leads from the circuit under test while changing the measurement function.
- 5) Operate the instrument only in the ambient temperature range of 32°F – 122°F ( 0°C – 50 °C ) and less than 80% Relative humidity.
- 6) Do not exceed the maximum rated voltage of each range and input terminal.
- 7) Always switch the power to its " Off " position when the instrument is not in use. Remove the batteries if not intend to use the instrument for a long period of time.

#### 5. MEASURING PROCEDURE

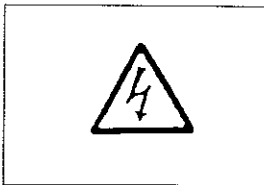

**Caution :**

**\* Do not apply the overload voltage, current to the input terminal !**

### 5-1 AC Watt/V/A/PF/Hz Measurement

- 1) Push the " Power switch " ( 3-2, Fig. 1 ) to " On " position.

On = 1, Off = 0

- 2) Select the " AC V/A/WATT Switch " ( 3-3, Fig. 1 ).
- 3) Select the " Current In Switch " ( 3-6, Fig. 1 ) to the " DIRECT " position.
- 4) Do not make any wire connection to the input terminals.  
If the watt display not zero, push the " WATT Zero Button " ( 3-8, Fig. 1 ) once, then watt display will show " 0 "

**Remark :**

*\* The " Watt zero Button " can be executed only under ACV & ACA are under zero condition ( no signal input ).*

- 5) Power off the " Power Source " of the measured installation.

Make the wire connection and connect the test leads into terminals ( 3-16, 3-17, 3-18, 3-19 ) as the Fig. 2

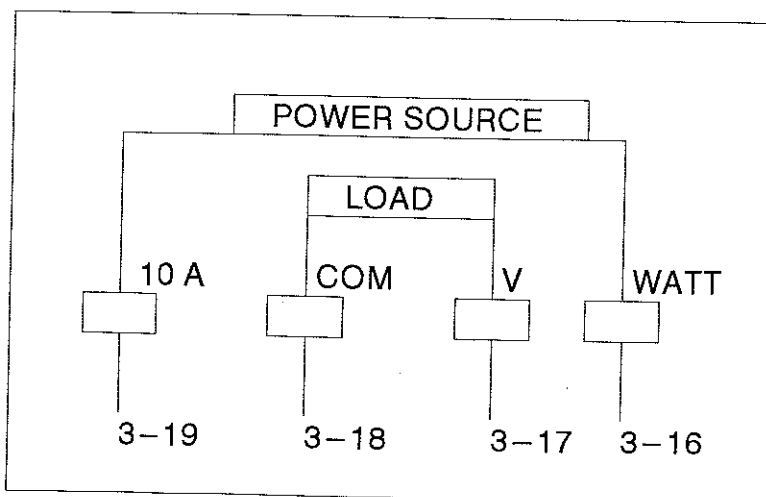

Fig. 2

- 6) \* Connect the " LOAD " to the terminals of 3-17, 3-18, refer Fig. 2.  
\* Connect the " POWER SOURCE " to the terminals of 3-16, 3-19, refer Fig. 2.

7) Power on the " Power Source " of the measured installation.

The " LCD display " ( 3-1, Fig. 1 ) will show the Watt, Voltage, Current, PF ( Power Factor ) at the same time.

- \* *Watt function is the true power (  $V \times A \times PF$  ) measurement.*
- \* *Voltage & Current function is the true rms measurement.*
- \* *For the Watt measurement, the max. input current should less than ACA 10A.*

**Line frequency ( Hz ) measurement :**

- 8) During the Watt measurement, push the " PF/Hz Button " ( 3-9, Fig. 1 ) once, will show Line frequency value instead of the PF value.  
\* *Push the " PF/Hz Button " again, the Hz value will disappear & the PF value will display again.*

**5-2 AC VA/V/A/PF/Hz Measurement**

All the measuring procedures are same as the above " 5-1 AC Watt/V/A/PF/Hz Measurement " except should push the " WATT/VA/Whr Button " ( 3-7, Fig. 1 ) once, then the display will show the VA, voltage, current, Hz at the same time.

- \* *The VA function is the apparent power (  $V \times A$  ) measurement.*
- \* *During the VA measurement, the LCD will show VA, Voltage, Current & Hz, it can not show the value of PF ( Power Factor ).*

### **5-3 AC Watt Hour ( Whr ) Measurement**

All the measuring procedures are same as the above " 5-1 AC Watt/V/A/PF/Hz Measurement " except should push the " WATT/VA/Whr Button " ( 3-7, Fig. 1 ) twice, then the display will show the Whr value along with the elapsed time.

- \* *The Whr ( Watt Hour ) is the value of Watt x hour.*
- \* *The Whr measurement will start at the moment after the " Whr " unit is displayed on the LCD display.*
- \* *The display of Whr measurement will stop ( hold ) when push the " Data Hold Button " ( 3-5, Fig. 1 ) once. Push the " Data Hold Button " once again will continue the Whr function.*

### **5-4 AC Voltage, AC Current Measurement**

1) Push the " Power switch " ( 3-2, Fig. 1 ) to " On " position.

On = 1, Off = 0

- 2) Select the " AC V/A/WATT Switch " ( 3-3, Fig. 1 ).
- 3) Select the " Current In Select Switch " ( 3-6, Fig. 1 ) to the " DIRECT " position.
- 4) **AC Voltage measurement**
  - a. Connect red test lead to " V/Ohm Terminal " ( 3-17, Fig. 1 ) and black test lead to " COM Terminal " ( 3-18, Fig. 1 ).
  - b. Connect test lead probes into circuit under test.
  - c. The display will show the AC voltage directly.
- 5) **AC Current measurement**
  - a. Connect red test lead to " Current ( 10 A ) Terminal " ( 3-19, Fig. 1 ) and black test lead to " COM Terminal " ( 3-18, Fig. 1 ).
  - b. Open the circuit in which current is to be measured. Now securely connect test leads in series with the load which the current is to be measured.
  - c. The display will show the AC current directly.
    - \* *The max. AC current input value should less than 10 A.*

### **5-5 DC Voltage, DC Current Measurement**

1) Push the " Power switch " ( 3-2, Fig. 1 ) to " On " position.

On = 1, Off = 0

2) Select the " DC V/A Switch " ( 3-4, Fig. 1 ).

3) Select the " Current In Select Switch " ( 3-6, Fig. 1 ) to the " DIRECT " position.

4) **DC Voltage measurement**

a. Connect red test lead to " V/Ohm Terminal " ( 3-17, Fig. 1 ) and black test lead to " COM Terminal " ( 3-18, Fig. 1 ).

b. Connect test lead probes into circuit under test.

c. The display will show the DC voltage directly.

***Remark :***

***When the " DC " mark on the LCD be flashed, it means the measured display value is negative DC voltage.***

5) **DC Current measurement**

a. Connect red test lead to " Current ( 10 A ) Terminal " ( 3-19, Fig. 1 ) and black test lead to " COM Terminal " ( 3-18, Fig. 1 ).

b. Open the circuit in which current is to be measured.  
Now securely connect test leads in series with the load which the current is to be measured.

c. The display will show the DC current directly.

***\* The max. DC current input value should less than 10 Ampere.***



### **5-6 Ohm Measurement**

- 1) Push the " Power switch " ( 3-2, Fig. 1 ) to " On " position.

**On = 1, Off = 0**

- 2) Select the " Ohm Switch " ( 3-5, Fig. 1 ).
- 3) Connect red test lead to " V/Ohm Terminal " ( 3-17, Fig. 1 ) and black test lead to " COM Terminal " ( 3-18, Fig. 1 ).
- 4) If the resistance being measured is connected to a circuit, turn off power to circuit being tested and discharge all capacitors.
- 5) Connect test lead probes into circuit (resistance) under test.
- 6) Read resistance value on digital display.

### **5-7 AC Watt, VA, Whr measurement, current input cooperate with CT ( current transformer )**

Other measurement procedures are same as the 5-1, 5-2, except :

- 1) Wire connection as following, ref. Fig. 3

**Voltage :**

" V Terminal " ( 3-17, Fig. 2 ) & " COM terminal " ( 3-18, Fig. 2 )

**Current :**

Current transformer output connect to the " 10A Terminal " ( 3-19, Fig. 2 ) & " COM terminal " ( 3-18, Fig. 2 )

- 2) Select the CT type, 100/5A or 1000/5A by push the " Current Mode Button " ( 3-12, Fig. 1 ). The LCD will show the marker " CT 100/5A ", " CT 1000/5A " when the CT type is selected.

Fig. 3

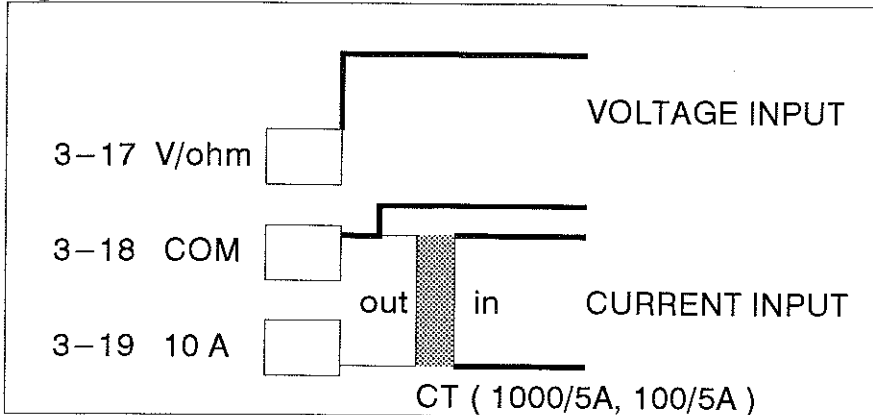

**5-8 AC Watt, VA, Whr measurement, current input cooperate with Clamp-On Probe**

Other measurement procedures are same as the 5-1, 5-2, except :

1) Wire connection , ref. Fig. 4

**Voltage :**

" V Terminal " ( 3-17, Fig. 2 ) & " COM terminal " ( 3-18, Fig. 2 )

**Current :**

The output plug of the inductive current probe ( 1 ACmV per 1 ACA, such as CA-502, CA-203...) connect to the " Clamp-On Current Input Terminals " ( 3-20, Fig. 2 ).

2) It should select the " Current In Switch " ( 3-6, Fig. 1 ) to the " CLAMP-ON " position, the display will show the marker " clamp1000A ".

Fig. 4

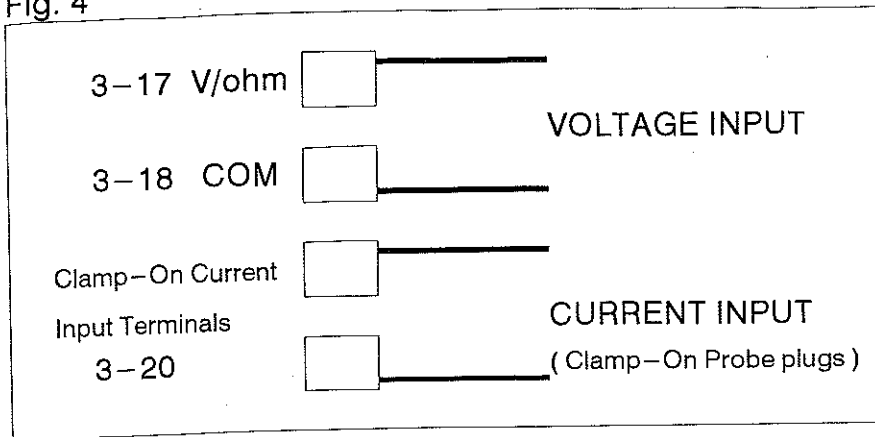

### 5-9 Data Hold

During the measurement, Push the "Data Hold Button" ( 3-11, Fig. 1 ) will hold the display values & LCD will show the " HOLD " marker.

*\* Push the "Data Hold Button" again will release the DATA HOLD function.*

*\* Data hold function is not available for ohm range.*

### 5-10 Peak Hold

During the measurement, Push the " Peak Hold Button " ( 3-10, Fig. 1 ) will hold the peak measurement values & LCD will show the " PK.H " marker.

**Peak Hold function only available for the " Watt value "**

*\* Push the "Data Hold Button" again will release the PEAK HOLD function.*

### 5-11 Alarm Setting

- 1) Alarm setting function only for the " Watt " display.
- 2) " Alarm Set Button " ( 3-15 ) is used to set the Max., Min. alarm value or set the alarm off ( display not show Max., Min. marker when adjust the Alarm Set Button ).
- 3) " > Button " ( 3-13, Fig. 1 ) is used to select the digit.
- 4) " ^ Button " ( 3-14, Fig. 1 ) is used to select the value ( 0, 1, 2.....9 ) of each digit.
- 5) The buzzer will alarm when the Watt alarm setting value larger than the " Max. " value or smaller than " Min. " value.

## 6. MAINTENANCE

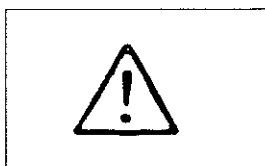
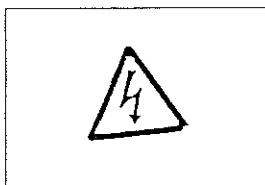

### **Caution :**

- \* Risk of electric shock !
- \* Remove power cord before open the battery cover !

## 7. RS232 PC SERIAL INTERFACE

The instrument features an RS232 output via 3.5 mm Terminal ( 3–14, Fig. 1).

The connector output is a 16 digit data stream which can be utilized to the user's specific application.

An RS232 lead with the following connection will be required to link the instrument with the PC serial input.

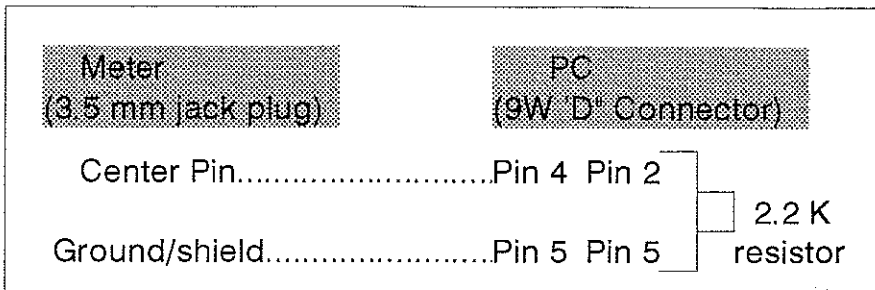

The 16 digit data stream will be displayed in the following format :

D15 D14 D13 D12 D11 D10 D9 D8 D7 D6 D5 D4 D3 D2 D1 D0

Each digit indicate the following status :

D0	End Word
D1 & D8	Display reading, D1 = LSD, D8 = MSD <i>For example :</i> <i>If the display reading is 1234, then D8 to D1 is :</i> <i>00001234</i>
D9	Decimal Point(DP), position from right to the left 0 = No DP, 1 = 1 DP, 2 = 2 DP, 3 = 3 DP
D10	Polarity 0 = Positive    1 = Negative

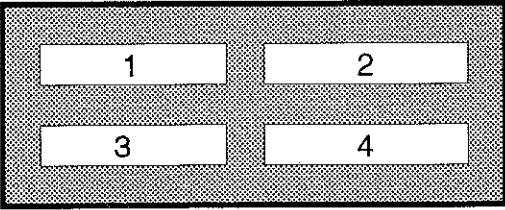
D11 & D12	Anunuciator for Display		
	Hz = 31	DCV = 34	DCA = 36
	ohm = 38	K ohm = 39	Watt = 47
	Hour = 61	VA = 63	kw/hr = 65
	Power factor = 54		
D13	1 = Top left display	2 = Top right display	
	3 = Bottom left display	4 = Bottom right display	
<i>to show display position</i>			LCD DISPLAY
D14	4		
D15	Start Word		

## 8. THE ADDRESS OF AFTER SERVICE CENTER



**FRANCAISE D'INSTRUMENTATION**  
**DISTRAME SA**

44, rue des Noës  
10000 Troyes

Tél : 03 25 71 28 95 Fax : 03 25 71 28 99

01-INF-10024c

Service Après Vente - Assuré par  
**FRANCAISE D'INSTRUMENTATION**  
☎ : 0821 210 400