



**PLEASE CHECK FOR CHANGE INFORMATION
AT THE REAR OF THIS MANUAL.**

**2235
OSCILLOSCOPE
OPERATORS**

INSTRUCTION MANUAL

**Tektronix, Inc.
P.O. Box 500
Beaverton, Oregon 97077**

070-4207-00
Product Group 46

Serial Number _____

First Printing OCT 1982
Revised APR 1987

Copyright © 1982 Tektronix, Inc. All rights reserved.
Contents of this publication may not be reproduced in any
form without the written permission of Tektronix, Inc.

Products of Tektronix, Inc. and its subsidiaries are covered
by U.S. and foreign patents and/or pending patents.

TEKTRONIX, TEK, SCOPE-MOBILE, and  are
registered trademarks of Tektronix, Inc. TELEQUIPMENT
is a registered trademark of Tektronix U.K. Limited.

Printed in U.S.A. Specification and price change privileges
are reserved.

INSTRUMENT SERIAL NUMBERS

Each instrument has a serial number on a panel insert, tag,
or stamped on the chassis. The first number or letter
designates the country of manufacture. The last five digits
of the serial number are assigned sequentially and are
unique to each instrument. Those manufactured in the
United States have six unique digits. The country of
manufacture is identified as follows:

B000000	Tektronix, Inc., Beaverton, Oregon, USA
100000	Tektronix Guernsey, Ltd., Channel Islands
200000	Tektronix United Kingdom, Ltd., London
300000	Sony/Tektronix, Japan
700000	Tektronix Holland, NV, Heerenveen, The Netherlands

TABLE OF CONTENTS

	Page		Page
LIST OF ILLUSTRATIONS	ii	SECTION 4 OPERATING PROCEDURES	
LIST OF TABLES	ii	INSTRUMENT	
OPERATORS SAFETY SUMMARY	iii	FAMILIARIZATION	4-1
SECTION 1 GENERAL INFORMATION		INTRODUCTION	4-1
INTRODUCTION	1-1	BASELINE TRACE	4-1
SPECIFICATION	1-1	DISPLAYING A SIGNAL	4-2
CALIBRATION	1-10	BASIC APPLICATIONS	4-7
REPACKAGING FOR SHIPMENT	1-10	INDEX TO BASIC	
SECTION 2 PREPARATION FOR USE		APPLICATION PROCEDURES	4-7
FIRST-TIME START UP	2-1	NONDELAYED	
SAFETY	2-1	MEASUREMENTS	4-7
LINE VOLTAGE	2-1	DELAYED-SWEEP	
POWER CORD	2-1	MAGNIFICATION	4-16
LINE FUSE	2-2	DELAYED-SWEEP	
INSTRUMENT COOLING	2-2	TIME MEASUREMENTS	4-18
CONTROLS, CONNECTORS,		SECTION 5 OPTIONS AND ACCESSORIES	
AND INDICATORS	2-3	OPTIONS	5-1
POWER, DISPLAY, AND		STANDARD ACCESSORIES	
PROBE ADJUST	2-3	INCLUDED	5-1
VERTICAL	2-4	OPTIONAL ACCESSORIES	5-1
HORIZONTAL	2-5		
TRIGGER	2-6	FRONT PANEL ILLUSTRATION	
REAR PANEL	2-8		
SECTION 3 OPERATING CONSIDERATIONS		CHANGE INFORMATION	
GENERAL OPERATING			
INFORMATION	3-1		
GRATICULE	3-1		
GROUNDING	3-1		
SIGNAL CONNECTIONS	3-1		
INPUT COUPLING CAPACITOR			
PRECHARGING	3-1		
OPERATOR'S ADJUSTMENTS	3-2		
TRACE ROTATION	3-2		
PROBE COMPENSATION	3-2		

LIST OF ILLUSTRATIONS

Figure		Page
1-1	Maximum input voltage vs frequency derating curve for CH 1 OR X, CH 2 OR Y, and EXT INPUT connectors	1-6
1-2	Physical dimensions of the 2235 Oscilloscope	1-9
2-1	Power cord clamp and line fuse	2-1
2-2	Voltage, power cord, and fuse data	2-2
2-3	Power, display, and probe adjust controls, connector, and indicator	2-3
2-4	Vertical controls and connectors	2-4
2-5	Horizontal controls	2-5
2-6	Trigger controls, connector, and indicator	2-6
2-7	Rear-panel connector	2-8
3-1	Graticule measurement markings	3-1
3-2	Probe compensation	3-3
4-1	Initial setup for instrument familiarization procedure	4-2
4-2	Peak-to-peak waveform voltage	4-7
4-3	Instantaneous voltage measurement	4-9
4-4	Algebraic addition	4-10
4-5	Common-mode rejection	4-10
4-6	Time duration	4-11
4-7	Rise time	4-11
4-8	Time difference between two time-related pulses	4-12
4-9	Phase difference	4-13
4-10	High-resolution phase difference	4-14
4-11	Delayed-sweep magnification	4-17
4-12	Pulse jitter	4-17
4-13	Time difference between repetitive pulses	4-18
4-14	B DELAY TIME POSITION control settings	4-19
4-15	Rise time, differential time method	4-19
4-16	Time difference between two time-related pulses, differential time method	4-20

LIST OF TABLES

Table		Page
1-1	Electrical Characteristics	1-1
1-2	Environmental Characteristics	1-7
1-3	Physical Characteristics	1-8
4-1	Equipment Required for Instrument Familiarization Procedure	4-1

OPERATORS SAFETY SUMMARY

The general safety information in this part of the summary is for both operating and servicing personnel. Specific warnings and cautions will be found throughout the manual where they apply and do not appear in this summary.

Terms in This Manual

CAUTION statements identify conditions or practices that could result in damage to the equipment or other property.

WARNING statements identify conditions or practices that could result in personal injury or loss of life.

Terms as Marked on Equipment

CAUTION indicates a personal injury hazard not immediately accessible as one reads the markings, or a hazard to property, including the equipment itself.

DANGER indicates a personal injury hazard immediately accessible as one reads the marking.

Symbols in This Manual



This symbol indicates where applicable cautionary or other information is to be found. For maximum input voltage see Table 1-1.

Symbols as Marked on Equipment



DANGER – High voltage.



Protective ground (earth) terminal.



ATTENTION – Refer to manual.

Power Source

This product is intended to operate from a power source that does not apply more than 250 volts rms between the supply conductors or between either supply conductor and ground. A protective ground connection by way of the grounding conductor in the power cord is essential for safe operation.

Grounding the Product

This product is grounded through the grounding conductor of the power cord. To avoid electrical shock, plug the power cord into a properly wired receptacle before connecting to the product input or output terminals. A protective ground connection by way of the grounding conductor in the power cord is essential for safe operation.

Danger Arising From Loss of Ground

Upon loss of the protective-ground connection, all accessible conductive parts (including knobs and controls that may appear to be insulating) can render an electric shock.

Use the Proper Power Cord

Use only the power cord and connector specified for your product.

Use only a power cord that is in good condition.

For detailed information on power cords and connectors see Figure 2-1.

Use the Proper Fuse

To avoid fire hazard, use only a fuse of the correct type, voltage rating and current rating as specified in the parts list for your product.

Do Not Operate in Explosive Atmospheres

To avoid explosion, do not operate this product in an explosive atmosphere unless it has been specifically certified for such operation.

Do Not Remove Covers or Panels

To avoid personal injury, do not remove the product covers or panels. Do not operate the product without the covers and panels properly installed.



The 2235 Oscilloscope.

GENERAL INFORMATION

INTRODUCTION

The TEKTRONIX 2235 Oscilloscope is a rugged, light-weight, dual-channel, 100-MHz instrument that features a bright, sharply defined trace on an 80- by 100-mm cathode-ray tube (crt). Its vertical system provides calibrated deflection factors from 2 mV per division to 5 V per division. Trigger circuits enable stable triggering over the full bandwidth of the vertical system. The horizontal system provides calibrated sweep speeds from 0.5 s per division to 50 ns per division along with delayed-sweep features for accurate relative-time measurements. A X10 magnifier extends the maximum sweep speed to 5 ns per division.

The instrument is shipped with the following standard accessories:

- | | |
|--------------------|------------------|
| 1 Operators manual | 2 Probe packages |
|--------------------|------------------|

For part numbers and further information about both standard and optional accessories, refer to the "Options and Accessories" section (Section 5) of this manual. Your Tektronix representative, local Tektronix Field Office, or Tektronix product catalog can also provide accessories information.

SPECIFICATION

The following electrical characteristics (Table 1-1) are valid for the 2235 when it has been adjusted at an ambient temperature between +20°C and +30°C, has had a warm-up period of at least 20 minutes, and is operating at an ambient temperature between 0°C and +50°C (unless otherwise noted).

Environmental characteristics are given in Table 1-2. The 2235 meets the requirements of MIL-T-28800C for Class 5 equipment, except where otherwise noted.

Physical characteristics of the instrument are listed in Table 1-3.

Table 1-1
Electrical Characteristics

Characteristics	Performance Requirements
VERTICAL DEFLECTION SYSTEM	
Deflection Factor	
Range	2 mV per division to 5 V per division in a 1-2-5 sequence.
Accuracy	
+15°C to +35°C	±2%.
0°C to +50°C	±3%.
Range of VOLTS/DIV Variable Control	Continuously variable between settings. Increases deflection factor by at least 2.5 to 1.

Table 1-1 (cont)

Characteristics	Performance Requirements
VERTICAL DEFLECTION SYSTEM (cont)	
Step Response	
Rise Time	
0°C to +35°C	
5 mV per Division to 5 V per Division	3.5 ns or less.
2 mV per Division	3.9 ns or less.
+35°C to +50°C	
5 mV per Division to 5 V per Division	4.1 ns or less. ^a
2 mV per Division	4.4 ns or less. ^a
Aberrations	
Positive-Going Step	
2 mV per Division to 0.5 V per Division	+4%, -4%, 4% p-p.
1 V per Division to 2 V per Division	+8%, -8%, 8% p-p.
5 V per Division	+10%, -10%, 10% p-p.
Bandwidth (-3 dB)	
0°C to +35°C	
5 mV per Division to 5 V per Division	Dc to at least 100 MHz.
2 mV per Division	Dc to at least 90 MHz.
+35°C to +50°C	
5 mV per Division to 5 V per Division	Dc to at least 90 MHz.
2 mV per Division	Dc to at least 80 MHz.
AC Coupled Lower Limit	10 Hz or less at -3 dB.
Bandwidth Limiter	Upper limits (-3 dB) bandpass at 20 MHz ±10%.
Chop Mode Switching Rate	500 kHz ±30%.
Input Characteristics	
Resistance	1 MΩ ±2%.
Capacitance	20 pF ±2 pF.

^aRise time is calculated from the formula:

$$\text{Rise Time} = \frac{0.35}{\text{Bandwidth } (-3 \text{ dB})}$$

Table 1-1 (cont)



Characteristics	Performance Requirements		
VERTICAL DEFLECTION SYSTEM (cont)			
Maximum Safe Input Voltage 	See Figure 1-1 for derating curve.		
DC Coupled	400 V (dc + peak ac) or 800 V ac p-p to 10 kHz or less.		
AC Coupled	400 V (dc + peak ac) or 800 V ac p-p to 10 kHz or less.		
Common-Mode Rejection Ratio (CMRR)	At least 10 to 1 at 50 MHz.		
Input Current	1.0 nA or less (0.5 division trace shift at 2 mV per division).		
Trace Shift with Attenuator Rotation	0.5 division or less: VOLTS/DIV Variable control in CAL detent.		
Trace Shift as VOLTS/DIV Variable Control Is Rotated	1.0 division or less.		
Trace Shift with Invert	1.5 divisions or less.		
Channel Isolation	Greater than 100 to 1 at 50 MHz.		
POSITION Control Range	At least ± 11 divisions from graticule center.		
TRIGGER SYSTEM			
A TRIGGER Sensitivity			
P-P AUTO and NORM/TV LINE Modes	10 MHz	60 MHz	100 MHz
Internal	0.3 div	1.0 div	1.5 div
External	35 mV	120 mV	200 mV
Lowest Useable Frequency in P-P AUTO Mode	20 Hz with 1.0 division internal or 100 mV external.		
TV FIELD Mode	1.0 division of composite sync.		
B TRIGGER Sensitivity (Internal Only)			
	10 MHz	60 MHz	100 MHz
	0.35 div	1.0 div	1.5 div
EXT INPUT			
Maximum Input Voltage 	400 V (dc + peak ac) or 800 V ac p-p at 10 kHz or less (see Figure 1-1).		
Input Resistance	1 M Ω $\pm 2\%$.		
Input Capacitance	20 pF ± 2.5 pF.		
AC Coupled	10 Hz or less at lower -3 dB point.		

Table 1-1 (cont)

Characteristics	Performance Requirements	
TRIGGER SYSTEM (cont)		
LEVEL Control Range		
A TRIGGER (NORM)		
INT	Can be set to any point of the trace that can be displayed.	
EXT, DC	At least ± 1.6 V, 3.2 V p-p.	
EXT, DC $\div 10$	At least ± 16 V, 32 V p-p.	
B TRIGGER		
Internal	Can be set to any point of the trace that can be displayed.	
VAR HOLDOFF Control	Increases A Sweep holdoff time by at least a factor of 10.	
Trigger View System		
Deflection Factor		
Internal	Same as vertical.	
External		
AC and DC	100 mV per division.	
DC $\div 10$	1 V per division.	
Accuracy	$\pm 20\%$.	
Delay Difference Between EXT INPUT and Either Vertical Channel	Less than 2.0 ns.	
HORIZONTAL DEFLECTION SYSTEM		
Sweep Rate		
Calibrated Range		
A Sweep	0.5 s per division to 0.05 μ s per division in a 1-2-5 sequence. X10 magnifier extends maximum sweep speed to 5 ns per division.	
B Sweep	50 ms per division to 0.05 μ s per division in a 1-2-5 sequence. X10 magnifier extends maximum sweep speed to 5 ns per division.	
Accuracy	Unmagnified	Magnified
+15°C to +35°C	$\pm 2\%$	$\pm 3\%$
0°C to +50°C	$\pm 3\%$	$\pm 4\%$
POSITION Control Range	Start of sweep to 10th division will position past the center vertical graticule line in X1 or 100th division in X10.	
Sweep Linearity	$\pm 5\%$.	

Table 1-1 (cont)

Characteristics	Performance Requirements
HORIZONTAL DEFLECTION SYSTEM (cont)	
Variable Control Range	Continuously variable between calibrated settings. Extends the A and B sweep speeds by at least a factor of 2.5.
Sweep Length	Greater than 10 divisions.
A/B SWP SEP Range	±3.5 divisions or greater.
Delay Time	Applies to 0.5 μs per division and slower.
Dial Control Range	<0.5 +300 ns to >10 divisions.
Jitter	One part or less in 20,000 (0.005%) of the maximum available delay time.
Differential Time Measurement Accuracy +15°C to +35°C	±1% +0.015 major dial division.
0°C to +50°C	±2% +0.015 major dial division.
X-Y OPERATION (X1 MAGNIFICATION)	
Deflection Factors	Same as Vertical Deflection System (with VOLTS/DIV Variable controls in CAL detent).
Accuracy X-Axis +15°C to +35°C	±3%.
0°C to +50°C	±4%.
Y-Axis	Same as Vertical Deflection System.
Bandwidth (–3 dB) X-Axis	Dc to at least 3 MHz.
Y-Axis	Same as Vertical Deflection System.
Phase Difference Between X- and Y-Axis Amplifiers	±3° from dc to 150 kHz.
PROBE ADJUST	
Output Voltage of PROBE ADJUST Jack	0.5 V ±5%.
Repetition Rate	1 kHz ±20%.
Z-AXIS INPUT	
Sensitivity	5 V causes noticeable modulation. Positive-going input decreases intensity.
Maximum Safe Input Voltage 	30 V (dc + peak ac) or 30 V p-p ac at 1 kHz or less.

Table 1-1 (cont)

Characteristics	Performance Requirements
Z-AXIS INPUT (cont)	
Input Resistance	10 kΩ ±10%.
POWER SOURCE	
Line Voltage Ranges	90 V to 250 V.
Line Frequency	48 Hz to 440 Hz.
Maximum Power Consumption	40 W (70 VA).
Line Fuse	1.0 A, 250 V, slow-blow.
CATHODE-RAY TUBE	
Display Area	80 by 100 mm.
Standard Phosphor	P31.
Nominal Accelerating Voltage	14 kV.

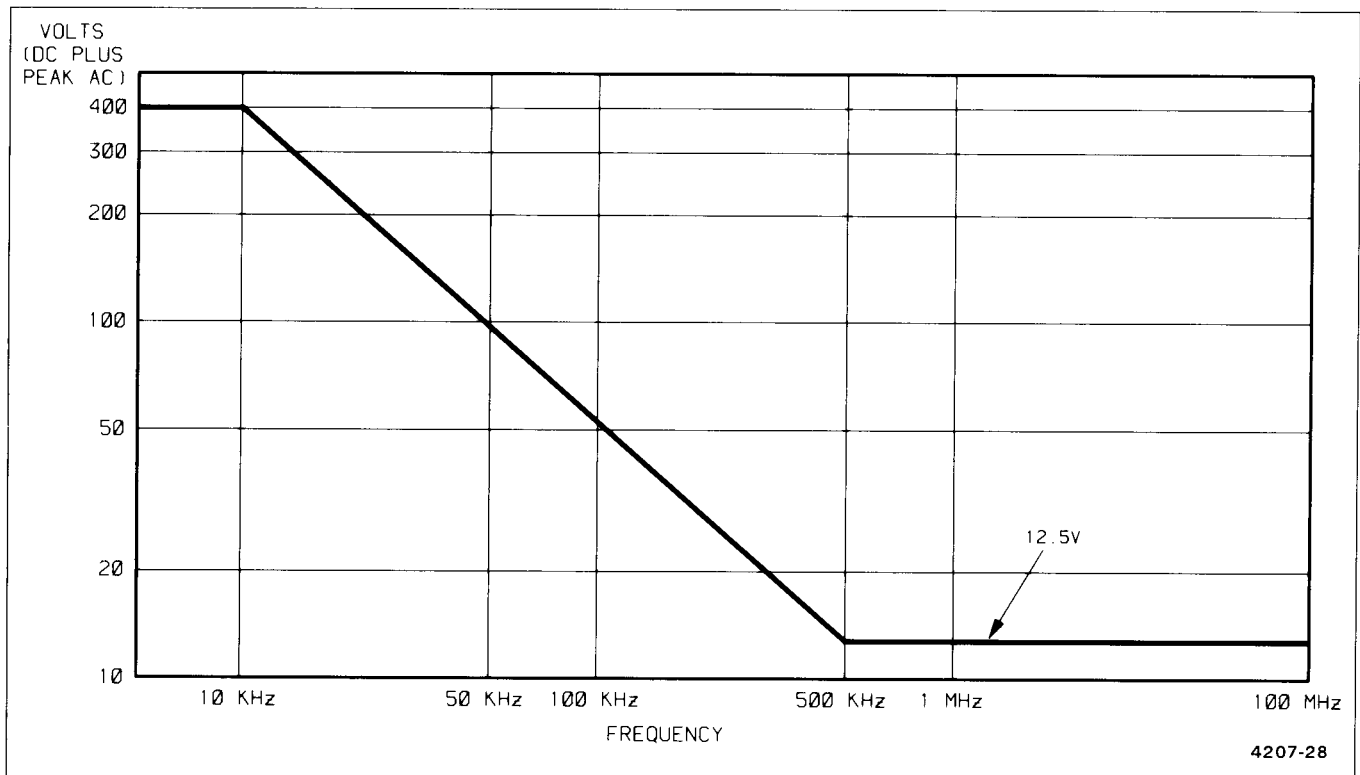

Figure 1-1. Maximum input voltage vs frequency derating curve for CH 1 OR X, CH 2 OR Y, and EXT INPUT connectors.

Table 1-2
Environmental Characteristics

Characteristics	Description
	<p style="text-align: center;">NOTE</p> <p style="text-align: center;"><i>The instrument meets all the following MIL-T-28800C requirements for Type III, Class 5 equipment.</i></p>
Temperature Operating	0°C to +50°C (+32°F to +122°F).
Nonoperating	−55°C to +75°C (−67°F to +167°F).
Altitude Operating	To 4,500 m (15,000 ft). Maximum operating temperature decreased 1°C per 300 m (1,000 ft) above 1,500 m (5,000 ft).
Nonoperating	To 15,000 m (50,000 ft).
Humidity (Operating and Nonoperating).	5 cycles (120 hours) referenced to MIL-T-28800B, for Type III, Class 5 instruments.
Vibration (Operating)	15 minutes along each of 3 major axis at a total displacement of 0.015 inch p-p (2.4 g's at 55 Hz) with frequency varied from 10 Hz to 55 Hz to 10 Hz in 1-minute sweeps. Hold for 10 minutes at 55 Hz in each of the 3 major axis. All major resonances must be above 55 Hz.
Shock (Operating and Nonoperating)	30 g's, half-sine, 11-ms duration, 3 shocks per axis each direction, for a total of 18 shocks.
EMI	Meets radiated and conducted emission requirements per VDE 0871 Class B.

Table 1-3
Physical Characteristics

Characteristics	Description
Weight With Power Cord	
With Cover, Probes, and Pouch	6.2 kg (13.7 lb).
Without Cover, Probes, and Pouch	5.2 kg (11.5 lb).
Domestic Shipping Weight	7.3 kg (16.0 lb).
Height	
With Feet and Handle	137 mm (5.4 in).
Width	
With Handle	360 mm (14.2 in).
Without Handle	327 mm (12.9 in).
Depth	
With Front Cover	445 mm (17.5 in).
Without Front Cover	440 mm (17.3 in).
With Handle Extended	511 mm (20.1 in).

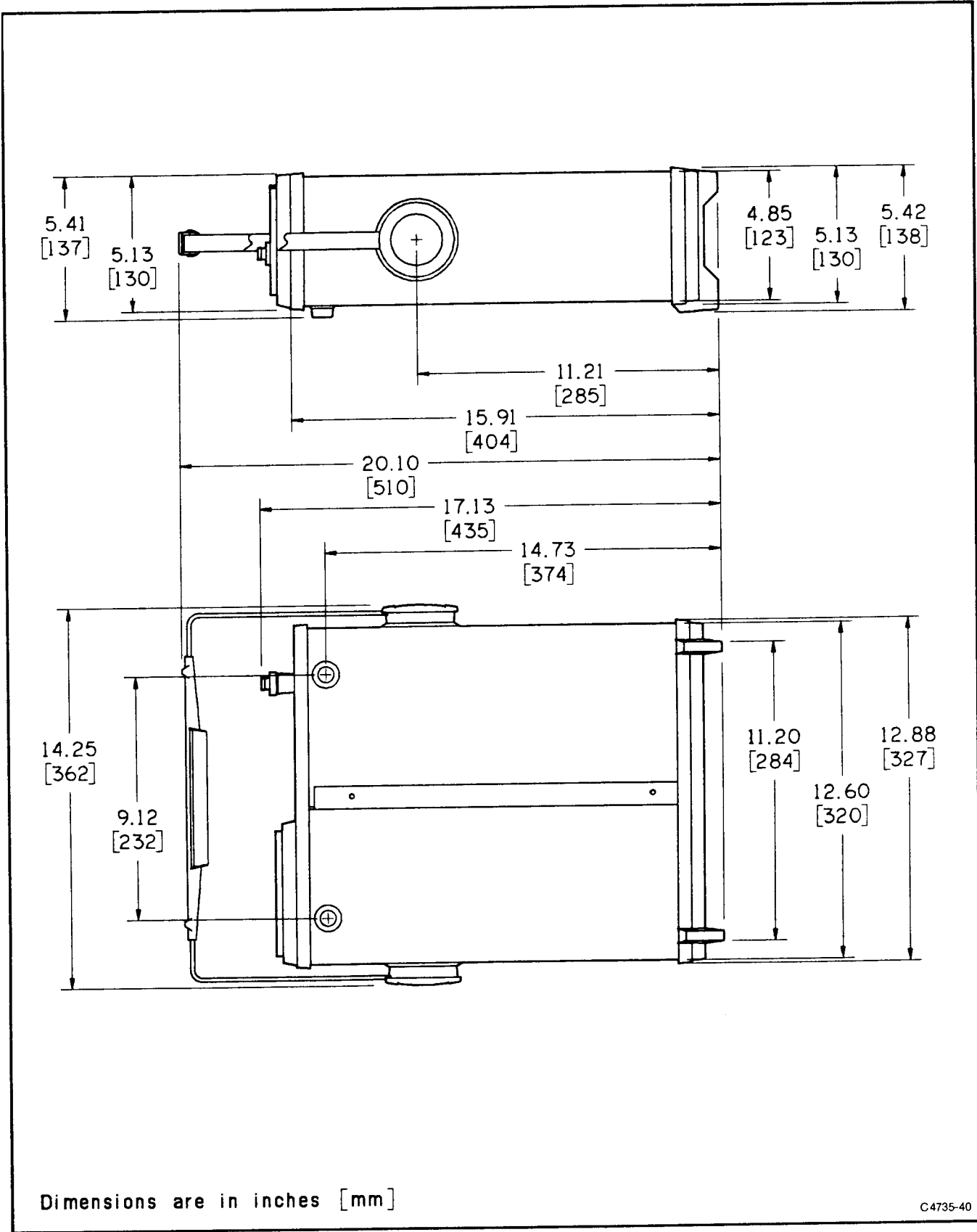

Figure 1-2. Physical dimensions of the 2235 Oscilloscope.

CALIBRATION

Instrument performance should be checked after every 2000 hours of operation or once each year if used infrequently. A more frequent interval may be necessary if your

instrument is subjected to harsh environments or severe usage.

REPACKAGING FOR SHIPMENT

If the instrument is to be shipped to a Tektronix Service Center for service or repair, attach a tag showing; owner (with address) and the name of an individual at your firm that can be contacted. Include complete instrument serial number and a description of the service required.

Save and reuse the package in which your instrument was shipped. If the original packaging is unfit for use or not available, repackage the instrument as follows:

Surround the instrument with polyethylene sheeting to protect its finish. Obtain a carton of corrugated cardboard having a carton test strength of 275 pounds and having inside dimensions of no less than six inches more than the instrument dimensions. Cushion the instrument by tightly packing three inches of dunnage or urethane foam between carton and instrument, on all sides. Seal carton with shipping tape or industrial stapler.

PREPARATION FOR USE

FIRST-TIME START UP

SAFETY

Refer to the "Operators Safety Summary" at the front of this manual for power source, grounding, and other safety considerations pertaining to the use of the 2235. Before connecting the instrument to a power source, carefully read the following information about line voltage, power cord, and fuse.

LINE VOLTAGE

This instrument is capable of continuous operation with input voltages that range from 90 V to 250 V nominal at frequencies from 48 Hz to 62 Hz.

POWER CORD

A detachable three-wire power cord with a three-contact plug is provided with each instrument for connecting to both the power source and protective ground. The power cord may be secured to the rear panel by a cord-set-securing clamp (see Figure 2-1). The protective-ground contact in the plug connects (through the protective-ground conductor) to the accessible metal parts of the instrument. For electrical-shock protection, insert this plug only into a power-source outlet that has a properly grounded protective-ground contact.

Instruments are shipped with the power cord specified by the customer. Available power-cord information is presented in Figure 2-2, and part numbers are listed in "Options and Accessories" (Section 5). Contact your Tektronix representative or local Tektronix Field Office for additional power-cord information.

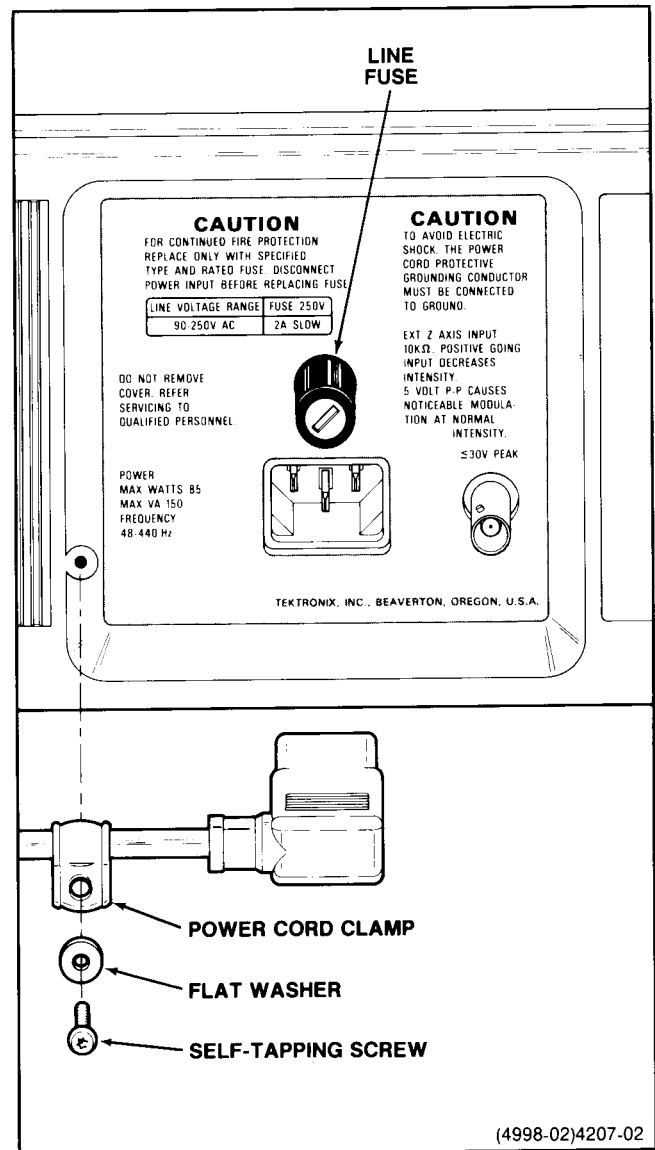

Figure 2-1. Power cord clamp and line fuse.





LINE FUSE

The instrument fuse holder is located on the rear panel (see Figure 2-2) and contains the line fuse. The following procedure can be used to verify that the proper fuse is installed or to install a replacement fuse.

1. Unplug the power cord from the power-input source (if applicable).
2. Press in and slightly rotate the fuse-holder cap counterclockwise to release it.
3. Pull the cap (with the attached fuse inside) out of the fuse holder.
4. Verify proper fuse value (see Figure 2-2).
5. Reinstall the fuse (or replacement fuse) and the fuse-holder cap.

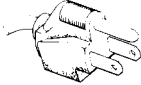
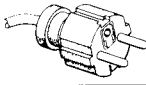
INSTRUMENT COOLING

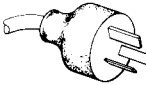
Always maintain adequate instrument cooling. The ventilation holes on both sides of the equipment cabinet and on the rear panel must remain free of obstructions.

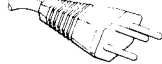
Plug Configuration	Usage	Line Voltage	Reference Standards
	North American 120V/ 15A	120V	ANSI C73.11 NEMA 5-15-P IEC 83
	Universal Euro 240V/ 10-16A	240V	CEE (7),II,IV,VII IEC 83
	UK 240V/ 13A	240V	BS 1363 IEC 83
	Australian 240V/ 10A	240V	AS C112
	North American 240V/ 15A	240V	ANSI C73.20 NEMA 6-15-P IEC 83
	Switzerland 220V/ 6A	220V	SEV
Abbreviations: ANSI — American National Standards Institute AS — Standards Association of Australia BS — British Standards Institution CEE — International Commission on Rules for the Approval of Electrical Equipment IEC — International Electrotechnical Commission NEMA — National Electrical Manufacturer's Association SEV — Schweizerischer Elektrotechnischer Verein			

(2931-21)4204-53

Figure 2-2. Voltage, power cord, and fuse data.

CONTROLS, CONNECTORS, AND INDICATORS

The following descriptions are intended to familiarize the operator with the location, operation, and function of the instrument's controls, connectors, and indicators.

POWER, DISPLAY, AND PROBE ADJUST

Refer to Figure 2-3 for location of items 1 through 8.

- ① **Internal Graticule**—Eliminates parallax viewing error between the trace and graticule lines. Rise-time amplitude and measurement points are indicated at the left edge of the graticule.
- ② **POWER Switch**—Turns instrument power on and off. Press in for ON; press again for OFF.
- ③ **Power Indicator**—An LED that illuminates when power is available to the instrument and the POWER switch is set to ON (button in).
- ④ **FOCUS Control**—Adjusts for optimum display definition.
- ⑤ **PROBE ADJUST Connector**—Provides an approximately 0.5-V, negative-going, square-wave voltage (at approximately 1 kHz) that permits an operator to compensate voltage probes and to check operation of the oscilloscope vertical system. It is not intended for verifying the accuracy of the vertical gain or time-base circuitry.
- ⑥ **BEAM FIND Switch**—When held in, compresses the display to within the graticule area and provides a visible viewing intensity to aid in locating off-screen displays.
- ⑦ **TRACE ROTATION Control**—Screwdriver adjustment used to align the crt trace with the horizontal graticule lines.
- ⑧ **A and B INTENSITY Controls**—Determine the brightness of the A and the B Sweep traces.

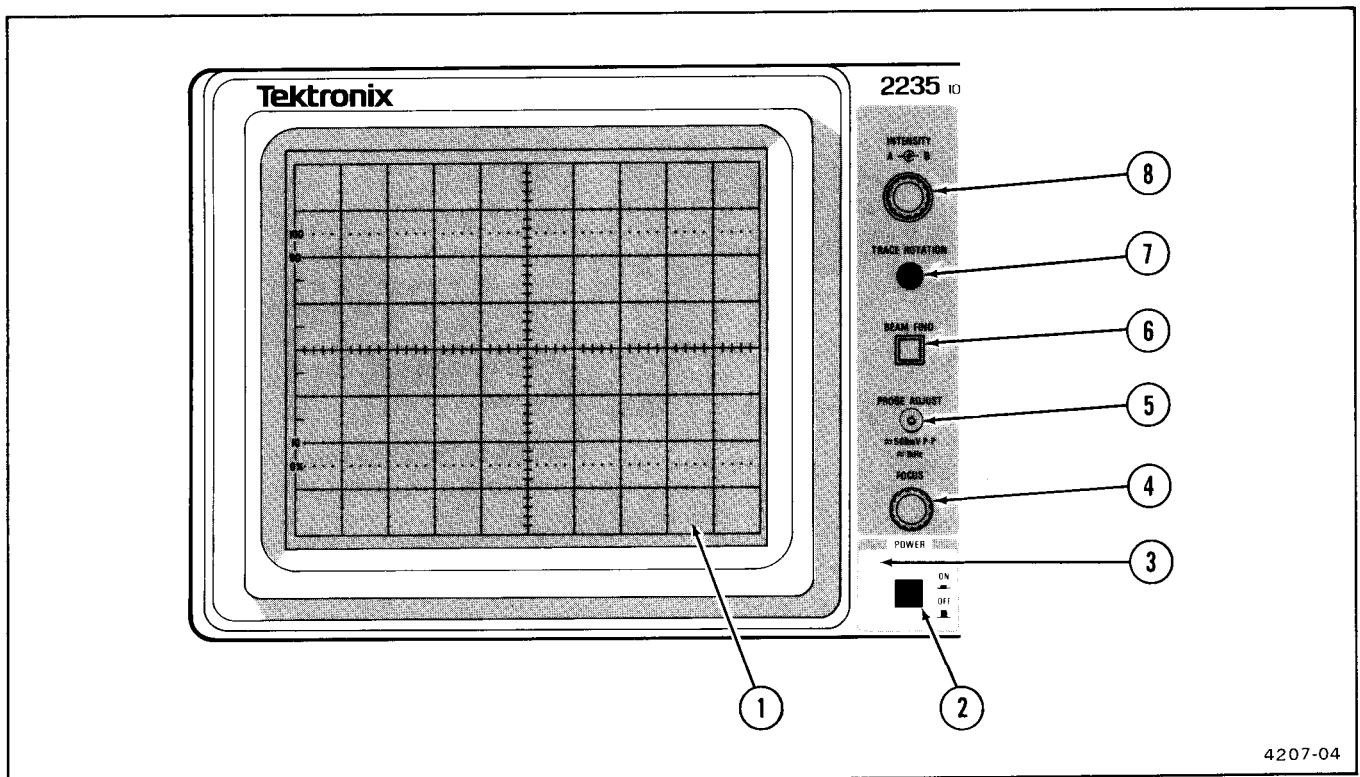

Figure 2-3. Power, display, and probe adjust controls, connector, and indicator.

VERTICAL

Refer to Figure 2-4 for location of items 9 through 17.

- 9 CH 1 VOLTS/DIV and CH 2 VOLTS/DIV Switches**—Used to select the vertical deflection factor in a 1-2-5 sequence. To obtain a calibrated deflection factor, the VOLTS/DIV variable control must be in the calibrated (CAL) detent (fully clockwise).

1X—Indicates the deflection factor selected when using either a 1X probe or a coaxial cable.

10X PROBE—Indicates the deflection factor selected when using a 10X probe.

- 10 VOLTS/DIV Variable Controls**—When rotated counterclockwise out of their calibrated detent positions, these controls provide continuously variable, uncalibrated deflection factors between the calibrated settings of the VOLTS/DIV switches.

- 11 CH 1 OR X and CH 2 OR Y Connectors**—Provide for application of external signals to the inputs of the vertical deflection system or for an X-Y display. In the X-Y mode, the signal connected to the CH 1 OR

X connector provides horizontal deflection, and the signal connected to the CH 2 OR Y connector provides vertical deflection.

- 12 Input Coupling (AC-GND-DC) Switches**—Used to select the method of coupling input signals to the vertical deflection system.

AC—Input signal is capacitively coupled to the vertical amplifier. The dc component of the input signal is blocked. Low-frequency limit (−3 dB point) is approximately 10 Hz.

GND—The input of the vertical amplifier is grounded to provide a zero (ground) reference-voltage display (does not ground the input signal). This switch position allows precharging the input coupling capacitor.

DC—All frequency components of the input signal are coupled to the vertical deflection system.

- 13 INVERT Switch**—Inverts the Channel 2 display when button is pressed in. Push button must be pressed in a second time to release it and regain a noninverted display.

- 14 VERTICAL MODE Switches**—Two three-position switches and two push-button switches are used to select the mode of operation for the vertical amplifier system.

CH 1—Selects only the Channel 1 input signal for display.

BOTH—Selects both Channel 1 and Channel 2 input signals for display. The BOTH position must be selected for either ADD, ALT, or CHOP operation.

CH 2—Selects only the Channel 2 input signal for display.

ADD—Displays the algebraic sum of the Channel 1 and Channel 2 input signals.

ALT—Alternately displays Channel 1 and Channel 2 input signals. The alternation occurs during retrace at the end of each sweep. This mode is useful for viewing both input signals at sweep speeds from 0.05 μ s per division to 0.2 ms per division.

CHOP—The display switches between the Channel 1 and Channel 2 input signals during the sweep. The switching rate is approximately 500 kHz. This mode is useful for viewing both Channel 1

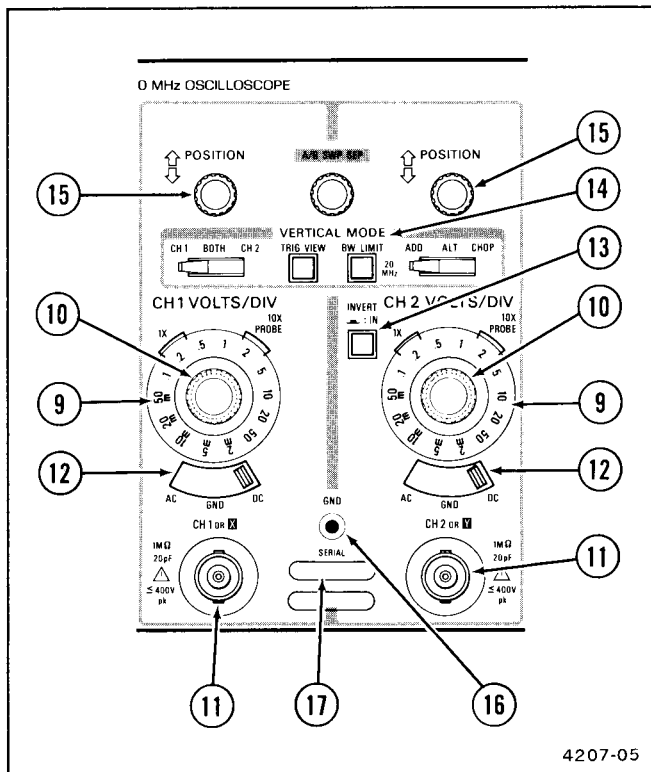

Figure 2-4. Vertical controls and connectors.

and Channel 2 input signals at sweep speeds from 0.5 ms per division to 0.5 s per division.

TRIG VIEW—Press in and hold this push button to display a sample of the signal present in the A Trigger amplifier (for all A SOURCE switch settings). All other signal displays are removed while the TRIG VIEW push button is held in.

BW LIMIT—When pressed in, this push-button switch limits the bandwidth of the vertical amplifier to approximately 20 MHz. Push button must be pressed a second time to release it and regain full 100-MHz bandwidth operation. Provides a method for reducing interference from high-frequency signals when viewing low-frequency signals.

- ⑮ **POSITION Controls**—Used to vertically position the display on the crt. When the SEC/DIV switch is set to X-Y, the Channel 2 POSITION control moves the display vertically (Y-axis), and the Horizontal POSITION control moves the display horizontally (X-axis).

- ⑯ **GND Connector**—Provides direct connection to the instrument chassis ground.

- ⑰ **SERIAL and Mod Slots**—The SERIAL slot is imprinted with the instrument's serial number. The Mod slot contains any option number that is installed in the instrument.

HORIZONTAL

Refer to Figure 2-5 for location of items 18 through 24.

- ⑱ **A and B SEC/DIV Switches**—Used to select the sweep speeds for the A and B Sweep generators in a 1-2-5 sequence. To obtain calibrated sweep speeds, the A and B SEC/DIV Variable control must be in the calibrated detent (fully clockwise).

A SEC/DIV—The calibrated sweep speed is shown between the two black lines on the clear plastic skirt. This switch also selects the delay time for delayed-sweep operation when used in conjunction with the B DELAY TIME POSITION control.

B SEC/DIV—The B Sweep speed is set by pulling out the (DLY'D SWEEP PULL) knob and rotating it clockwise to a setting opposite the white line scribed on the knob. The B Sweep circuit is used only for delayed-sweep operation.

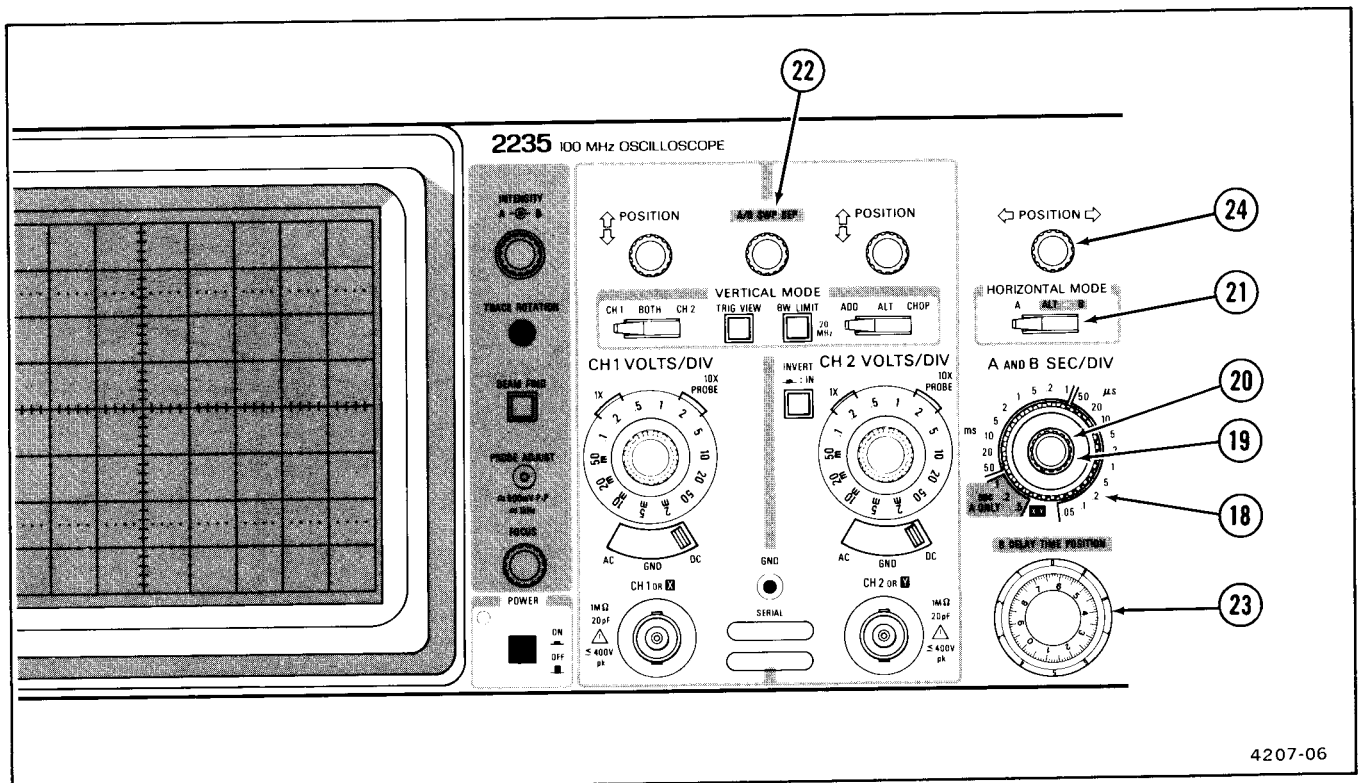

Figure 2-5. Horizontal controls.

- 19 **A and B SEC/DIV Variable Control**—Provides continuously variable, uncalibrated A Sweep speeds to at least 2.5 times the calibrated setting. It extends the slowest sweep speed to at least 1.25 s per division.
- 20 **X10 Magnifier Switch**—To increase displayed sweep speed by a factor of 10, pull out the A and B SEC/DIV Variable knob. The fastest sweep speed can be extended to 5 ns per division. Push in the A and B SEC/DIV Variable knob to regain the X1 sweep speed.
- 21 **HORIZONTAL MODE Switch**—This three-position switch determines the mode of operation for the horizontal deflection system.

A—Horizontal deflection is provided by the A Sweep generator at a sweep speed determined by the A SEC/DIV switch setting.

ALT—Alternates the horizontal displays between the A Sweep (with an intensified zone) and the B Delayed Sweep. The A Sweep speed is determined by the setting of the A SEC/DIV switch. The B Sweep speed and the length of the intensified zone on the A Sweep are both determined by the B SEC/DIV switch setting.

B—Horizontal deflection is provided by the B Sweep generator at a sweep speed determined by the B SEC/DIV switch setting. The start of the B Sweep is delayed from the start of the A Sweep by a time determined by the settings of both the A SEC/DIV switch and the B DELAY TIME POSITION control.

- 22 **A/B SWP SEP Control**—Vertically positions the B Sweep trace with respect to the A Sweep trace when ALT HORIZONTAL MODE is selected.
- 23 **B DELAY TIME POSITION Control**—Selects the amount of delay time between the start of the A Sweep and the start of the B Sweep. Delay time is variable from 0.5 times to 10 times the A SEC/DIV switch setting.
- 24 **POSITION Control**—Horizontally positions both the A Sweep and the B Sweep displays and horizontally positions X-axis in the X-Y mode.

TRIGGER

Refer to Figure 2-6 for locations of items 25 through 34.

- 25 **A TRIGGER Mode Switches**—Three push-button switches that determine the trigger mode for the A Sweep.

SGL SWP RESET—Press in the spring-return push button momentarily to arm the A Sweep circuit for a single-sweep display. This mode operates the same as NORM, except only one sweep is displayed for each trigger signal. Another sweep cannot be displayed until the SGL SWP RESET push button is momentarily pressed in again to reset the A Sweep circuit. This mode is useful for displaying and photographing either nonrepetitive signals or signals that cause unstable conventional displays (e.g., signals that vary in amplitude, shape, or time).

P-P AUTO-TV LINE—Permits triggering on waveforms having repetition rates of at least 20 Hz and television lines. Sweep free-runs in the absence of an adequate trigger signal or when the repetition rate is below 20 Hz. The range of the A TRIGGER LEVEL control is restricted to the peak-to-peak range of the trigger signal.

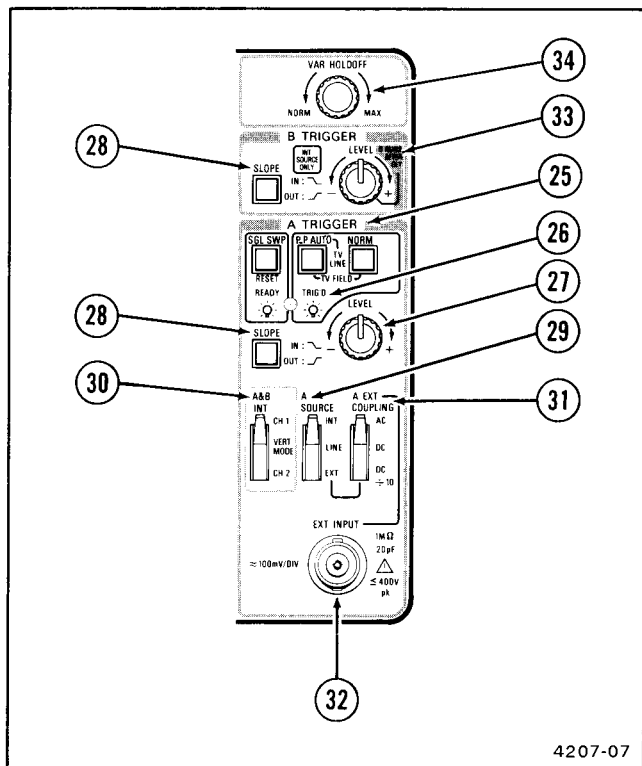

Figure 2-6. Trigger controls, connector, and indicator.

NORM—Sweep is initiated when an adequate trigger signal is applied. In the absence of a trigger signal, no baseline trace will be present.

TV FIELD—Press in both P-P AUTO and NORM push buttons. Permits triggering on television field signals.

- 26 **TRIG'D READY Indicator**—The LED illuminates when either the P-P AUTO or the NORM Trigger Mode is selected to indicate that the A Sweep is triggered (TRIG'D). When the SGL SWP RESET button is momentarily pressed in, the LED illuminates to indicate that the A Trigger circuit is armed (READY) for a single-sweep display.

- 27 **A TRIGGER LEVEL Control**—Selects the amplitude point on the trigger signal at which the sweep is triggered.

- 28 **SLOPE Switches**—Select the slope of the signal that triggers the sweep.

OUT:  —When push button is released out, sweep is triggered from the positive-going slope of the trigger signal.

IN:  —When push button is pressed in, sweep is triggered from the negative-going slope of the trigger signal.

- 29 **A SOURCE Switch**—Determines the source of the trigger signal that is coupled to the input of the A Trigger circuit.

INT—Permits triggering on signals that are applied to the CH 1 OR X and CH 2 OR Y input connectors. The source of the internal signal is selected by the A & B INT switch.

LINE—Selects the power-source waveform as the source of the trigger signal. This trigger source is useful when vertical-input signals are time related (multiple or submultiple) to the frequency of the power-source voltage.

EXT—Permits triggering on signals applied to the EXT INPUT connector.

- 30 **A & B INT Switch**—Selects the source of the internal triggering signal when the A SOURCE switch is set to INT.

CH 1—The signal applied to the CH 1 OR X input connector is the source of the trigger signal.

VERT MODE—The internal trigger source is determined by the signals selected for display by the VERTICAL MODE switches.

CH 2—The signal applied to the CH 2 OR Y input connector is the source of the trigger signal.

- 31 **A EXT COUPLING Switch**—Determines the method used to couple external signals to the A Trigger circuit from the EXT INPUT connector.

AC—Signals above 60 Hz are capacitively coupled to the input of the A Trigger circuit. Any dc components are blocked, and signals below 60 Hz are attenuated.

DC—All components of the signal are coupled to the input of the A Trigger circuit. This position is useful for displaying low-frequency or low-repetition-rate signals.

DC÷10—External trigger signals are attenuated by a factor of 10. All components of the signal are coupled to the input of the A Trigger circuit.

- 32 **EXT INPUT Connector**—Provides a means of introducing external signals into the A Trigger circuit through the A EXT COUPLING switch.

- 33 **B TRIGGER LEVEL Control**—Selects the amplitude point on the trigger signals at which the sweep is triggered. When fully clockwise (B RUNS AFTER DLY), the B Sweep circuit runs immediately following the delay time selected by the A SEC/DIV switch and the B DELAY TIME POSITION control.

- 34 **VAR HOLDOFF Control**—Provides continuous control of holdoff time between sweeps. Increases the holdoff time by at least a factor of 10. This control improves the ability to trigger on aperiodic signals (such as complex digital waveforms).

REAR PANEL

Refer to Figure 2-7 for location of item 35.

- 35 **EXT Z-AXIS Connector**—Provides a means of connecting external signals to the Z-axis amplifier to intensity modulate the crt display. Applied signals do not affect display waveshape. Signals with fast rise times and fall times provide the most abrupt intensity change, and a 5-V p-p signal will produce noticeable modulation. The Z-axis signals must be time-related to the display to obtain a stable presentation on the crt.

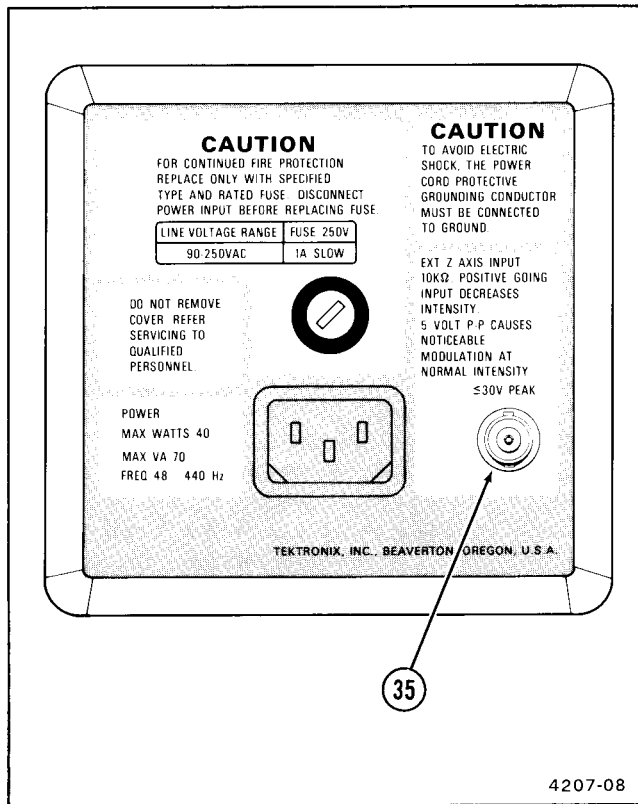

Figure 2-7. Rear-panel connector.

OPERATING CONSIDERATIONS

GENERAL OPERATING INFORMATION

GRATICULE

The graticule is internally marked on the faceplate of the crt to enable accurate measurements without parallax error (see Figure 3-1). It is marked with eight vertical and ten horizontal major divisions. Each major division is divided into five subdivisions. The vertical deflection factors and horizontal timing are calibrated to the graticule so that accurate measurements can be made directly from the crt. Also, percentage markers for the measurement of rise and fall times are located on the left side of the graticule.

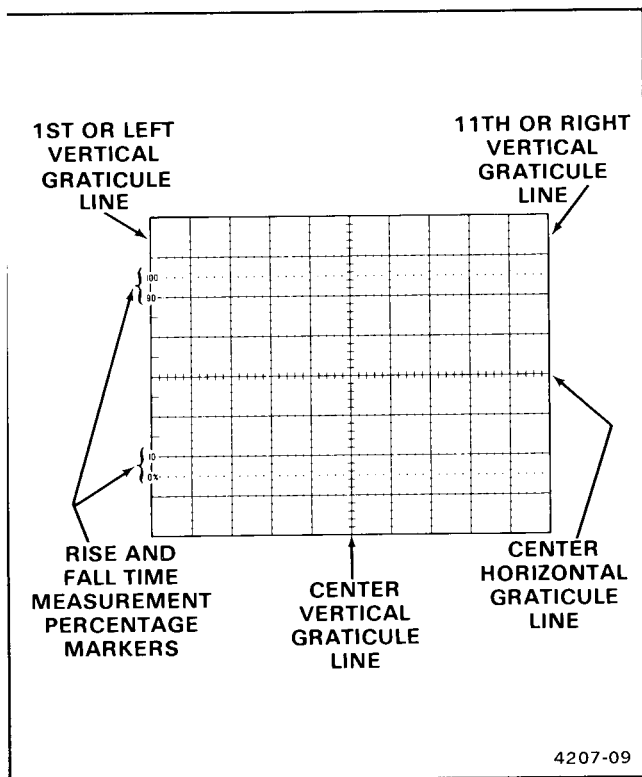

Figure 3-1. Graticule measurement markings.

GROUNDING

The most reliable signal measurements are made when the 2235 and the unit under test are connected by a common reference (ground lead), in addition to the signal lead or probe. The probe's ground lead provides the best grounding method for signal interconnection and ensures the maximum amount of signal-lead shielding in the probe cable. A separate ground lead can also be connected from the unit under test to the oscilloscope GND connector located on the front panel.

SIGNAL CONNECTIONS

Generally, probes offer the most convenient means of connecting an input signal to the instrument. They are shielded to prevent pickup of electromagnetic interference, and the supplied 10X probe offers a high input impedance that minimizes circuit loading. This allows the circuit under test to operate with a minimum of change from its normal condition as measurements are being made.

Coaxial cables may also be used to connect signals to the input connectors, but they may have considerable effect on the accuracy of a displayed waveform. To maintain the original frequency characteristics of an applied signal, only high-quality, low-loss coaxial cables should be used. Coaxial cables should be terminated at both ends in their characteristic impedance. If this is not possible, use suitable impedance-matching devices.

INPUT COUPLING CAPACITOR PRECHARGING

When the input coupling switch is set to GND, the input signal is connected to ground through the input coupling capacitor in series with a 1-M Ω resistor to form a pre-charging network. This network allows the input coupling

Operating Considerations—2235 Operators

capacitor to charge to the average dc-voltage level of the signal applied to the probe. Thus, any large voltage transients that may accidentally be generated will not be applied to the amplifier input when the input coupling switch is moved from GND to AC. The precharging network also provides a measure of protection to the external circuitry by reducing the current levels that can be drawn from the external circuitry during capacitor charging.

Use the following procedure whenever the probe tip is connected to a signal source having a different dc level than that previously applied, especially if the dc-level difference is more than 10 times the VOLTS/DIV switch setting:

1. Set the AC-GND-DC switch to GND before connecting the probe tip to a signal source.

2. Insert the probe tip into the oscilloscope GND connector.

3. Wait several seconds for the input coupling capacitor to discharge.

4. Connect the probe tip to the signal source.

5. Wait several seconds for the input coupling capacitor to charge.

6. Set the AC-GND-DC switch to AC. The display will remain on the screen, and the ac component of the signal can be measured in the normal manner.

OPERATOR'S ADJUSTMENTS

TRACE ROTATION

Normally, the resulting baseline trace will be parallel to the horizontal graticule lines, and the Trace Rotation adjustment should not be required. If adjustment is needed, perform the following procedure:

1. Preset instrument controls and obtain a baseline trace (refer to "Instrument Familiarization" in Section 4).

2. Use the Channel 1 POSITION control to move the baseline trace to the center horizontal graticule line.

3. If the resulting trace is not parallel to the center horizontal graticule line, use a small flat-bit screwdriver to adjust the TRACE ROTATION control and align the trace with the center horizontal graticule line.

PROBE COMPENSATION

Misadjustment of probe compensation is one of the sources of measurement error. Most attenuator probes are equipped with a compensation adjustment. To ensure

optimum measurement accuracy, always compensate the oscilloscope probes before making measurements. Probe compensation is accomplished as follows:

1. Preset instrument controls and obtain a baseline trace (refer to "Instrument Familiarization").

2. Connect the two 10X probes (supplied with the instrument) to the CH 1 and CH 2 input connectors.

3. Set both VOLTS/DIV switches to 0.1 (10X PROBE) and set both AC-GND-DC switches to DC.

4. Select CH 1 VERTICAL MODE and insert the tip of the Channel 1 probe into the PROBE ADJUST output jack.

5. Using the approximately 1-kHz PROBE ADJUST square-wave signal as the input, obtain a display of the signal (refer to "Instrument Familiarization").

6. Set the A SEC/DIV switch to display several cycles of the PROBE ADJUST signal. Use the Channel 1 POSITION control to vertically center the display.

7. Check the waveform presentation for overshoot and rolloff (see Figure 3-2). If necessary, adjust the probe compensation for flat tops on the waveforms. Refer to the instructions supplied with the probe for details of compensation adjustment.

8. Select CH 2 VERTICAL MODE and connect the Channel 2 probe tip to the PROBE ADJUST output jack.

9. Use the Channel 2 POSITION control to vertically center the display and repeat step 7 for the Channel 2 probe.

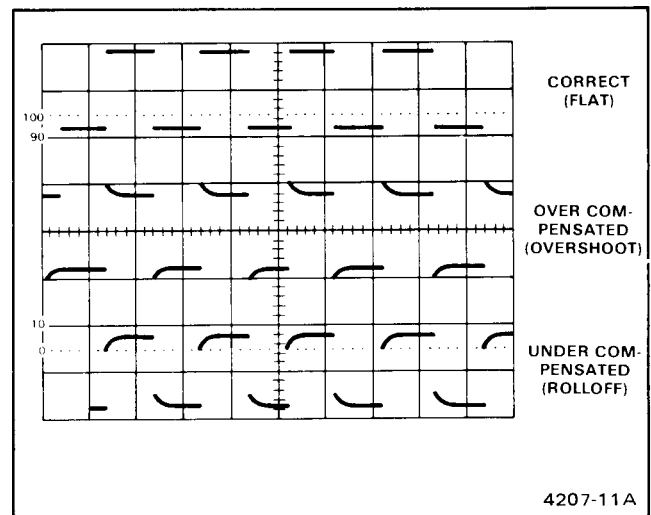

Figure 3-2. Probe compensation.

OPERATING PROCEDURES

INSTRUMENT FAMILIARIZATION

INTRODUCTION

The procedures in this part are designed to assist the user in quickly becoming familiar with the 2235. They provide information which demonstrates the use of all the controls, connectors, and indicators and will enable the user to efficiently operate the instrument.

Before proceeding with these instructions, verify that the POWER switch is OFF (push button out); then plug the power cord into the power-source outlet.

Should an improper indication or instrument malfunction be noted during the performance of these procedures, first verify correct operation of associated equipment. If the malfunction persists, refer the instrument to qualified service personnel for repair or adjustment.

The equipment listed in Table 4-1, or equivalent equipment, is required to complete these familiarization procedures.

Table 4-1
Equipment Required for Instrument Familiarization Procedure

Description	Minimum Specification
Square-Wave Generator	Signal amplitude: 2 mV to 50 V. Output signal: 1-kHz square wave. Fast-rise repetition rate: 1 kHz to 100 kHz. Signal amplitude: 100 mV to 1 V.
Dual-Input Coupler	Connectors: bnc-female-to-dual-bnc-male.
Cable (2 required)	Impedance: 50 Ω . Length: 42 in. Connectors: bnc.
Adapter	Connectors: bnc-female-to-bnc female.
Termination	Impedance: 50 Ω . Connectors: bnc.

BASELINE TRACE

First obtain a baseline trace, using the following procedure.

1. Preset the instrument front-panel controls as follows:

Display

A and B INTENSITY	Fully counterclockwise (minimum)
FOCUS	Midrange

Vertical (Both Channels)

AC-GND-DC	AC
VOLTS/DIV	50 m (1X)
VOLTS/DIV Variable	CAL detent (fully clockwise)
VERTICAL MODE	CH 1
BW LIMIT	Full (push button out)
INVERT	Off (push button out)
POSITION	Midrange

Horizontal

A and B SEC/DIV	Locked together at 0.5 ms
SEC/DIV Variable	CAL detent (fully clockwise)
HORIZONTAL MODE	A
X10 Magnifier	Off (variable knob in)
POSITION	Midrange
B DELAY TIME	
POSITION	Fully counterclockwise
A/B SWP SEP	Midrange

A TRIGGER

VAR HOLDOFF	NORM (fully counterclockwise)
Mode	P-P AUTO
SLOPE	OUT: 
LEVEL	Midrange
A & B INT	VERT MODE
A SOURCE	INT
A EXT COUPLING	AC

B TRIGGER

SLOPE	OUT: 
LEVEL	Fully clockwise

2. Press in the POWER switch button (ON).

3. Adjust the A INTENSITY control for desired display brightness.

4. Adjust the Vertical and Horizontal POSITION controls to center the trace on the screen.

NOTE

Normally, the resulting trace will be parallel with the center horizontal graticule line and should not require adjustment. If trace alignment is required, see the "Trace Rotation" adjustment procedure in the "Operator's Adjustments" part.

DISPLAYING A SIGNAL

After obtaining a baseline trace, you are now ready to connect an input signal and display it on the crt screen.

1. Connect the square-wave generator output to both the CH 1 and CH 2 inputs as shown in Figure 4-1.

2. Set the square-wave generator for a 1-kHz square-wave signal and adjust its output to obtain a 4-division vertical display.

3. Adjust the Channel 1 POSITION control to center the display vertically on the crt screen.

4. Adjust the A TRIGGER LEVEL control, if necessary, to obtain a stable triggered display.

NOTE

The READY-TRIG'D indicator should illuminate to indicate that the A Sweep is triggered.

5. Rotate the FOCUS control between its maximum clockwise and counterclockwise positions. The display should become blurred on either side of the optimum control setting.

6. Set the FOCUS control for a sharp, well-defined display over the entire trace length.

7. Move the display off the crt screen using the Channel 1 POSITION control.

8. Press in and hold the BEAM FIND push button; the display should reappear on the screen. Adjust both the

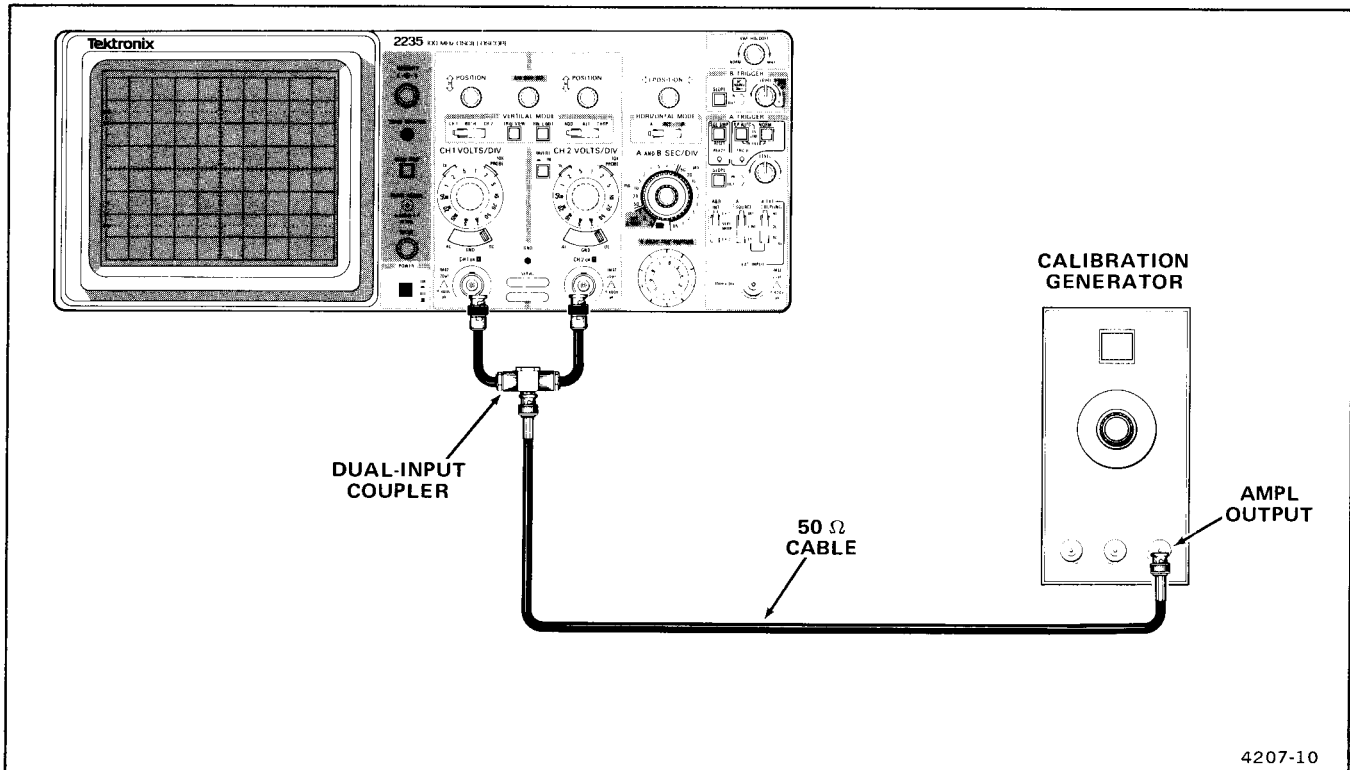

Figure 4-1. Initial setup for instrument familiarization procedure.

Channel 1 and the Horizontal POSITION controls to center the trace both vertically and horizontally. Release the BEAM FIND button; the display should remain within the viewing area.

9. Adjust the A INTENSITY control counterclockwise until the display disappears.

10. Press in and hold the BEAM FIND push button; the display should reappear. Release the BEAM FIND button and adjust the A INTENSITY control to desired display brightness.

Using the Vertical Section

1. Set the Channel 1 AC-GND-DC switch to GND.
2. Use the Channel 1 POSITION control to adjust the trace to the center horizontal graticule line.
3. Set the Channel 1 AC-GND-DC switch to DC.
4. Observe that the bottom of the display remains at the center horizontal graticule line (ground reference).
5. Set the Channel 1 AC-GND-DC switch to AC.
6. Observe that the display is centered approximately at the center horizontal line.
7. Rotate the CH 1 VOLTS/DIV Variable control fully counterclockwise.
8. Observe that minimum vertical deflection occurs when the VOLTS/DIV Variable control is fully counterclockwise.
9. Rotate the CH 1 VOLTS/DIV Variable control fully clockwise to the CAL detent.
10. Select CH 2 VERTICAL MODE and again perform preceding steps 1 through 9 using Channel 2 controls. Performance should be similar to Channel 1.
11. Set both CH 1 and CH 2 VOLTS/DIV switches to 0.1 (1X) for 2-division displays.

12. Select BOTH and ADD VERTICAL MODE and observe that the resulting display is 4 divisions in amplitude. Both Channel 1 and Channel 2 POSITION controls should move the display. Recenter the display on the crt screen.

13. Press in the Channel 2 INVERT push button to invert the Channel 2 signal.

14. Observe that the display is a straight line, indicating that the algebraic sum of the two signals is zero.

15. Set the CH 2 VOLTS/DIV switch to 50 m (1X).

16. Observe the 2-division display, indicating that the algebraic sum of the two signals is no longer zero.

17. Press in the Channel 2 INVERT push button again to release it. Observe a noninverted display having a 6-division signal amplitude.

18. Set both Channel 1 and Channel 2 AC-GND-DC switches to GND.

19. Set the CH 1 VOLTS/DIV switch to 50 m (1X).

20. Select ALT VERTICAL MODE. Position the Channel 1 trace two divisions above the center graticule line and position the Channel 2 trace two divisions below the center graticule line.

21. Rotate the A SEC/DIV switch throughout its range (except X-Y). The display will alternate between Channel 1 and Channel 2 at all sweep speeds. This mode is most useful for sweep speeds from 0.05 μ s to 0.2 ms per division.

22. Select CHOP VERTICAL MODE and rotate the A SEC/DIV switch throughout its range (except X-Y). A dual-trace display will be presented at all sweep speeds, but unlike the ALT mode, both Channel 1 and Channel 2 signals are displayed for each sweep on a time-shared basis. This mode is most useful for sweep speeds from 0.5 ms to 0.5 s per division.

23. Select CH 1 VERTICAL MODE and set Channel 1 AC-GND-DC switch to AC. Recenter the display on the screen.

24. Return the A SEC/DIV switch to 0.5 ms.

25. Press in and hold the TRIG VIEW push button. Observe the Channel 1 trigger signal that is present in the A Trigger amplifier.

NOTE

When using TRIG VIEW VERTICAL MODE, trigger signals applied by any of the A SOURCE switch positions will be displayed on the crt screen. Trigger signals will remain stable when positioned in the center graticule area by the A TRIGGER LEVEL control.

26. Release the TRIG VIEW VERTICAL MODE push button.

Using the Horizontal Section

1. Note the display at 0.5 ms sweep speed for future comparison in step 3.

2. Set the A SEC/DIV switch to 5 ms and pull the SEC/DIV Variable control knob out to obtain X10 sweep magnification.

3. Observe that the display is similar to that obtained in step 1.

4. Rotate the Horizontal POSITION control throughout its range. Observe that the display can be positioned to either side of the center vertical graticule line.

5. Push in the SEC/DIV Variable control knob to return to a X1 sweep.

6. Set the A and B SEC/DIV switches to 0.1 ms.

7. Rotate the VAR HOLDOFF control fully clockwise.

8. Observe that the crt trace starts to flicker as the holdoff between sweeps is increased.

9. Return the VAR HOLDOFF control to its NORM position (fully counterclockwise).

10. Return the A and B SEC/DIV switches to 0.5 ms. Note the display for future comparison in step 12.

11. Rotate the SEC/DIV Variable control out of the CAL detent to its maximum counterclockwise position.

12. Observe that the sweep speed is approximately 2.5 times slower than in step 10, as indicated by more cycles displayed on the screen.

13. Return the SEC/DIV Variable control to the CAL detent (fully clockwise).

Using the A Trigger Section

1. Rotate the A TRIGGER LEVEL control between its maximum clockwise and counterclockwise positions. The display will remain triggered over the full range of the A TRIGGER LEVEL control.

2. Return the A TRIGGER LEVEL control to midrange.

3. Set the A TRIGGER SLOPE to IN: . Observe that the display starts on the negative-going slope of the applied signal.

4. Return the A TRIGGER SLOPE switch to OUT: . Observe that the display starts on the positive-going slope of the applied signal.

5. Set the A & B INT switch to CH 1, the VERTICAL MODE switch to CH 2, and the Channel 1 AC-GND-DC switch to GND. Observe that the display free-runs.

6. Return the Channel 1 AC-GND-DC switch to AC.

7. Set the A & B INT switch to CH 2, the VERTICAL MODE switch to CH 1, and the Channel 2 AC-GND-DC switch to GND. Observe that the display free-runs.

8. Return the Channel 2 AC-GND-DC switch to AC and set the A & B INT switch to CH 1.

9. Set the A TRIGGER Mode switch to NORM.

10. Rotate the A TRIGGER LEVEL control between its maximum clockwise and counterclockwise positions. Observe that the READY-TRIG'D light illuminates only when the display is correctly triggered.

11. Readjust the A TRIGGER LEVEL control for a stable display.

12. Remove the square-wave signal from the CH 1 input connector.

13. Press in the A TRIGGER SGL SWP push button momentarily for single-sweep operation.

14. Observe that the READY-TRIG'D light illuminates, indicating that the A Trigger circuit is armed (READY) for a single-sweep display. No display should be present on the crt screen.

15. Reconnect the square-wave signal to the CH 1 input connector. A single sweep of the applied signal should appear on the screen. When the READY-TRIG'D light is out, another single sweep cannot be displayed until the SGL SWP button is pressed in again to reset the A Trigger circuit.

16. Set the A SOURCE switch to EXT. Move the square-wave signal from the CH 2 input connector to the EXT INPUT connector.

17. Set the A TRIGGER Mode switch to P-P AUTO.

18. Set the CH 1 VOLTS/DIV switch to 0.5 (1X) and adjust the output of the square-wave generator to provide a 4-division display. Adjust the A TRIGGER LEVEL control for a stable display and note the range over which a stable display can be obtained (for comparison in step 20).

19. Set the A EXT COUPLING switch to DC÷10.

20. Observe that adjustment of the A TRIGGER LEVEL control provides a triggered display over a narrower range than in preceding step 18, indicating trigger-signal attenuation.

21. Move the square-wave signal from the EXT INPUT connector to the CH 2 input connector. Set the A SOURCE switch to INT and adjust the A TRIGGER LEVEL control to the midrange position.

NOTE

The A TRIGGER mode can be used to trigger on either the TV Line or TV Field. For familiarization with these functions see TV Line Signal and TV Field Signal in the "Basic Applications" part of this section.

Using the Delayed-Sweep Controls

1. Set the B SEC/DIV switch to 50 μ s.

2. Select ALT HORIZONTAL MODE. Ensure that the B TRIGGER LEVEL control is fully clockwise (B RUNS AFTER DLY) and that the B DELAY TIME POSITION control is fully counterclockwise.

3. Adjust the B INTENSITY control for desired B Sweep display brightness.

4. Adjust the Channel 1 POSITION and the A/B SWP SEP controls as required to display the A Sweep (with the intensified zone) above the B Delayed Sweep. The displays alternate between the A Sweep (upper) and the B Delayed Sweep (lower). Adjust the A and B INTENSITY controls as necessary to view the two displays.

5. Observe that the intensified zone is approximately one division in length at the start of the A Sweep and that the B Delayed Sweep displays the intensified portion of the A Sweep.

6. Rotate the B DELAY TIME POSITION control; the intensified zone of the A Sweep and the display of the B Delayed Sweep will move continuously across the crt screen.

7. Select the B HORIZONTAL MODE and observe that only the B Delayed Sweep is now displayed on the crt screen.

8. Observe that the display moves continuously across the crt screen as the B DELAY TIME POSITION control is rotated. Return the B DELAY TIME POSITION control to the fully counterclockwise position.

9. Select the ALT HORIZONTAL MODE and set the B SEC/DIV switch to 0.5 ms.

Using the B Trigger Section

1. Rotate the B TRIGGER LEVEL control counterclockwise to the midrange position, then adjust it for a stable display.

2. Observe that both the intensified zone and the B Delayed Sweep displays disappear and reappear as the B TRIGGER LEVEL control approaches midrange. Adjust the B TRIGGER LEVEL control for a stable display at the midrange position.

Operating Procedures—2235 Operators

3. Rotate the B DELAY TIME POSITION control throughout its range. Observe that the intensified zone of the A Sweep appears to jump between the positive slopes of the display.

4. Set the B TRIGGER SLOPE switch to IN:  and observe that the intensified portion begins on the negative slope.

5. Observe that the length of the B Delayed Sweep decreases when the B DELAY TIME POSITION control is rotated clockwise and increases when the control is rotated counterclockwise.

6. Select the A HORIZONTAL MODE.

Using the X-Y Mode

1. Set both the CH 1 and CH 2 VOLTS/DIV switches to 1 (1X) and adjust the generator output to provide a 5-division display.

2. Select X-Y mode by switching the A SEC/DIV switch to its fully counterclockwise position.

3. Adjust the A INTENSITY control for desired display brightness. Observe that two dots are displayed diagonally. This display can be positioned horizontally with the Horizontal POSITION control and vertically with the Channel 2 POSITION control. Note that the dots are separated by 5 horizontal divisions and 5 vertical divisions.

4. Set both the CH 1 and CH 2 VOLTS/DIV switches to 2 (1X). Note that the dots are now separated by 2.5 horizontal divisions and 2.5 vertical divisions.

5. Return the A SEC/DIV switch to 0.5 ms and adjust the A INTENSITY control for desired display brightness.

Using the Z-Axis Input

1. Disconnect the dual-input coupler from the CH 2 input connector and connect a bnc-female-to-bnc-female adapter to the disconnected end of the coupler.

2. Connect a 42-inch, 50- Ω bnc cable from the Z-AXIS INPUT connector (located on the rear panel) to the dual-input coupler via the bnc-female-to-bnc-female adapter.

3. Set the Channel 1 VOLTS/DIV switch to 1 (1X) and adjust the output of the square-wave generator to provide a 5-division display.

4. Observe that the positive peaks of the waveform are blanked, indicating intensity modulation (adjust the A INTENSITY control as necessary).

5. Disconnect the 50- Ω cable from the Z-AXIS INPUT connector and disconnect the dual-input coupler from the CH 1 input connector.

Using the Bandwidth Limit Feature

1. Connect a fast-rise positive-output calibration signal through a 42-inch, 50- Ω cable and a 50- Ω termination to the CH 1 input connector.

2. Set the CH 1 VOLTS/DIV switch to 50 mV (1X) and adjust the square-wave generator output to provide a 4-division display.

3. Set the A SEC/DIV switch to 0.5 μ s and adjust the square-wave generator fast-rise positive-output signal frequency to 1 MHz. Adjust the generator frequency to provide approximately 5 cycles of the displayed signal.

4. Press in the BW LIMIT VERTICAL MODE push button and observe the rounding-off at the front corners of the display. This indicates a decrease in the frequency response of the vertical amplifier.

BASIC APPLICATIONS

INDEX TO BASIC APPLICATION PROCEDURES

Nondelayed Measurements	Page
AC Peak-to-Peak Voltage	4-7
Instantaneous DC Voltage	4-8
Algebraic Addition	4-9
Common-Mode Rejection	4-9
Time Duration	4-10
Frequency	4-11
Rise Time	4-11
Time Difference Between Two Time-Related Pulses.	4-12
Phase Difference	4-12
Amplitude Comparison.	4-13
Time Comparison	4-14
TV Line Signal	4-15
TV Field Signal.	4-15
Delayed-Sweep Magnification	
Magnified Sweep Runs After Delay.	4-16
Pulse Jitter Time Measurement.	4-17
Triggered Magnified Sweep	4-17
Delayed-Sweep Time Measurements	
Time Difference Between Repetitive Pulses	4-18
Rise Time	4-19
Time Difference Between Two Time-Related Pulses.	4-20

NOTE

This procedure may also be used to make voltage measurements between any two points on the waveform.

1. Preset instrument controls and obtain a baseline trace.
2. Apply the ac signal to either vertical-channel input connector and set the VERTICAL MODE switch to display the channel used.
3. Set the appropriate VOLTS/DIV switch to display about five divisions of the waveform, ensuring that the VOLTS/DIV Variable control is in the CAL detent.
4. Adjust the A TRIGGER LEVEL control to obtain a stable display.
5. Set the A SEC/DIV switch to a position that displays several cycles of the waveform.
6. Vertically position the display so that the negative peak of the waveform coincides with one of the horizontal graticule lines (see Figure 4-2, Point A).

NONDELAYED MEASUREMENTS

After becoming familiar with the capabilities of the 2235 Oscilloscope, the operator can then adopt a convenient method for making a particular measurement. The following information describes the recommended procedures and techniques for making basic types of measurements with your instrument. When a procedure first calls for presetting instrument controls and obtaining a baseline trace, refer to the "Instrument Familiarization" part in this section and perform steps 1 through 4 under "Baseline Trace."

AC Peak-to-Peak Voltage

To make a peak-to-peak voltage measurement, use the following procedure:

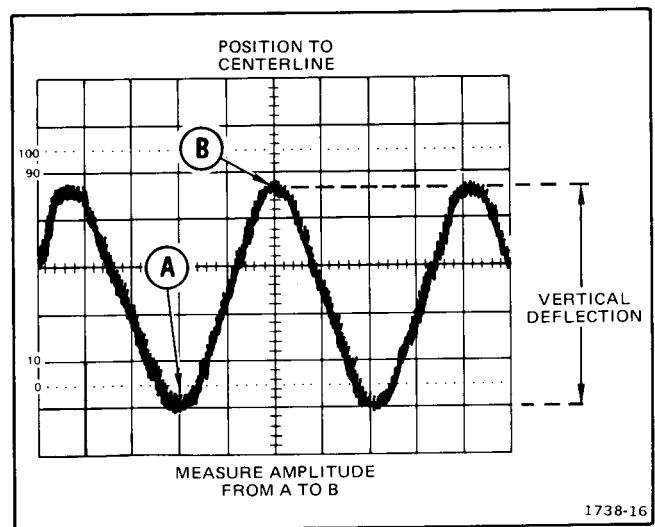

Figure 4-2. Peak-to-peak waveform voltage.

Operating Procedures—2235 Operators

7. Horizontally position the display so that one of the positive peaks coincides with the center vertical graticule line (see Figure 4-2, Point B).

8. Measure the vertical deflection from peak to peak (see Figure 4-2, Point A to Point B).

NOTE

If the amplitude measurement is critical or if the trace is thick (as a result of hum or noise on the signal), a more accurate value can be obtained by measuring from the top of a peak to the top of a valley. This will eliminate trace thickness from the measurement.

9. Calculate the peak-to-peak voltage, using the following formula:

$$\text{Volts (p-p)} = \begin{array}{l} \text{vertical} \\ \text{deflection} \\ \text{(divisions)} \end{array} \times \begin{array}{l} \text{VOLTS/DIV} \\ \text{switch} \\ \text{setting} \end{array} \times \begin{array}{l} \text{probe} \\ \text{attenuation} \\ \text{factor} \end{array}$$

EXAMPLE: The measured peak-to-peak vertical deflection is 4.6 divisions (see Figure 4-2) with a VOLTS/DIV switch setting of 0.5, using a 10X probe.

Substituting the given values:

$$\text{Volts (p-p)} = 4.6 \text{ div} \times 0.5 \text{ V/div} \times 10 = 23 \text{ V.}$$

Instantaneous DC Voltage

To measure the dc level at a given point on a waveform, use the following procedure:

1. Preset instrument controls and obtain a baseline trace.

2. Apply the signal to either vertical-channel input connector and set the VERTICAL MODE switch to display the channel used.

3. Verify that the VOLTS/DIV Variable control is in the CAL detent and set the AC-GND-DC switch to GND.

4. Vertically position the baseline trace to the center horizontal graticule line.

5. Set the AC-GND-DC switch to DC. If the waveform moves above the centerline of the crt, the voltage is positive.

If the waveform moves below the centerline of the crt, the voltage is negative.

NOTE

If using Channel 2, ensure that the Channel 2 INVERT switch is in its noninverting mode (push button out).

6. Set the AC-GND-DC switch to GND and position the baseline trace to a convenient reference line, using the Vertical POSITION control. For example, if the voltage to be measured is positive, position the baseline trace to the bottom graticule line. If a negative voltage is to be measured, position the baseline trace to the top graticule line. Do not move the Vertical POSITION control after this reference line has been established. The ground reference line can be checked at any later time by switching the AC-GND-DC switch to GND.

7. Set the AC-GND-DC switch to DC.

8. If the voltage-level measurement is to be made with respect to a voltage level other than ground, apply the reference voltage to the unused vertical-channel input connector. Then position its trace to the reference line.

9. Adjust the A TRIGGER LEVEL control to obtain a stable display.

10. Set the A SEC/DIV switch to a position that displays several cycles of the signal.

11. Measure the divisions of vertical deflection between the reference line and the desired point on the waveform at which the dc level is to be determined (see Figure 4-3).

12. Calculate the instantaneous voltage, using the following formula:

$$\begin{array}{l} \text{Instantaneous} \\ \text{Voltage} \end{array} = \begin{array}{l} \text{vertical} \\ \text{deflection} \\ \text{(divisions)} \end{array} \times \begin{array}{l} \text{polarity} \\ \text{(+ or -)} \end{array} \\ \times \begin{array}{l} \text{VOLTS/DIV} \\ \text{switch} \\ \text{setting} \end{array} \times \begin{array}{l} \text{probe} \\ \text{attenuation} \\ \text{factor} \end{array}$$

EXAMPLE: The measured vertical deflection from the reference line is 4.6 divisions (see Figure 4-3), the waveform is above the reference line, the VOLTS/DIV switch is set to 2, a 10X attenuator probe is being used, and the A TRIGGER SLOPE switch is set to OUT: .

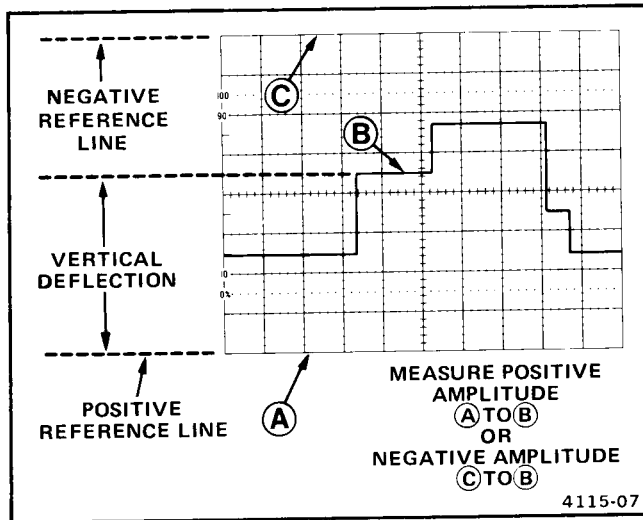

Figure 4-3. Instantaneous voltage measurement.

Substituting the given values:

$$\text{Instantaneous Voltage} = 4.6 \text{ div} \times (+1) \times 2 \text{ V/div} \times 10 = 92 \text{ V.}$$

Algebraic Addition

With the VERTICAL MODE switches set to BOTH and ADD, the waveform displayed is the algebraic sum of the signals applied to the Channel 1 and Channel 2 inputs (CH 1 + CH 2). If the Channel 2 INVERT push button is pressed in, the waveform displayed is the difference between the signals applied to the Channel 1 and Channel 2 inputs (CH 1 - CH 2). The total deflection factor in the ADD mode is equal to the deflection factor indicated by either VOLTS/DIV switch (when both VOLTS/DIV switches are set to the same deflection factor). A common use for the ADD mode is to provide a dc offset for a signal riding on top of a high dc level.

The following general precautions should be observed when using the ADD mode.

- a. Do not exceed the input voltage rating of the oscilloscope.
- b. Do not apply signals that exceed the equivalent of about eight times the VOLTS/DIV switch settings, since large voltages may distort the display. For example, with a VOLTS/DIV switch setting of 0.5, the voltage applied to that channel should not exceed approximately 4 volts.
- c. Use Channel 1 and Channel 2 POSITION control settings which most nearly position the signal on each channel to midscreen, when viewed in either CH 1 or

CH 2 VERTICAL MODE. This ensures the greatest dynamic range for ADD mode operation.

- d. To attain similar response from each channel, set both the Channel 1 and Channel 2 AC-GND-DC switches to the same position.

EXAMPLE: Using the graticule center line as 0 V, the Channel 1 signal is at a 3-division, positive dc level (see Figure 4-4A).

1. Multiply 3 divisions by the VOLTS/DIV switch setting to determine the dc-level value.

2. To the Channel 2 input connector, apply a negative dc level (or positive level, using the Channel 2 INVERT switch) whose value was determined in step 1 (see Figure 4-4B).

3. Select ADD and BOTH VERTICAL MODE to place the resultant display within the operating range of the vertical POSITION controls (see Figure 4-4C).

Common-Mode Rejection

The ADD mode can also be used to display signals that contain undesirable frequency components. The undesirable components can be eliminated through common-mode rejection. The precautions given under the preceding "Algebraic Addition" procedure should be observed.

EXAMPLE: The signal applied to the Channel 1 input connector contains unwanted ac-input-power-source frequency components (see Figure 4-5A). To remove the undesired components, use the following procedure:

1. Preset instrument controls and obtain a baseline trace.
2. Apply the signal containing the unwanted line-frequency components to the Channel 1 input.
3. Apply a line-frequency signal to the Channel 2 input.
4. Select BOTH and ALT VERTICAL MODE and press in the Channel 2 INVERT push button.
5. Adjust the Channel 2 VOLTS/DIV switch and Variable control so that the Channel 2 display is approximately

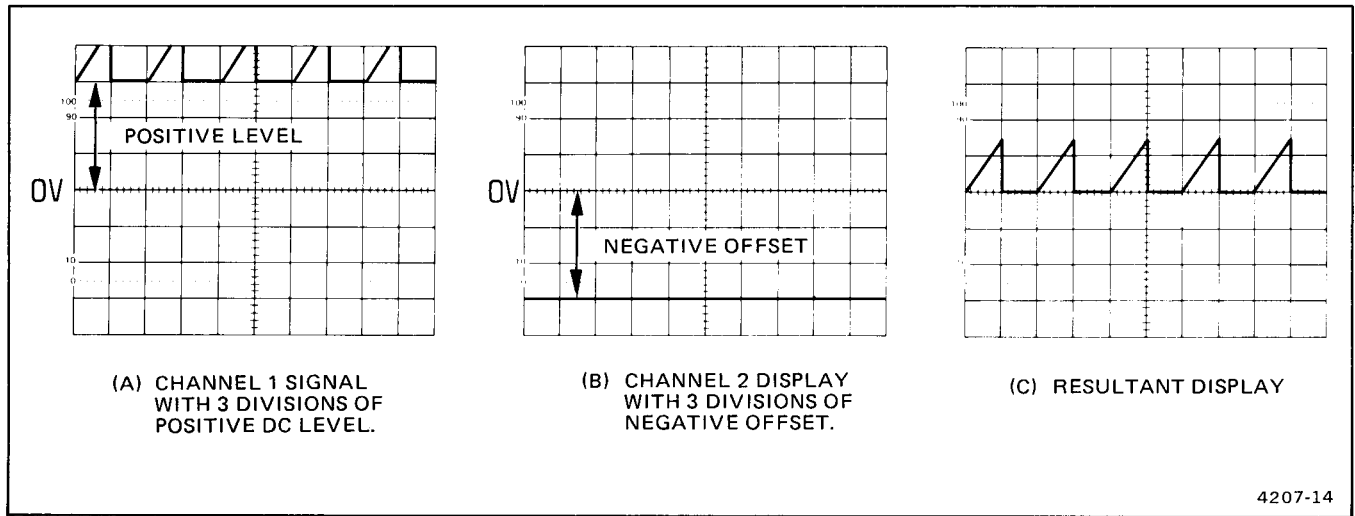

Figure 4-4. Algebraic addition.

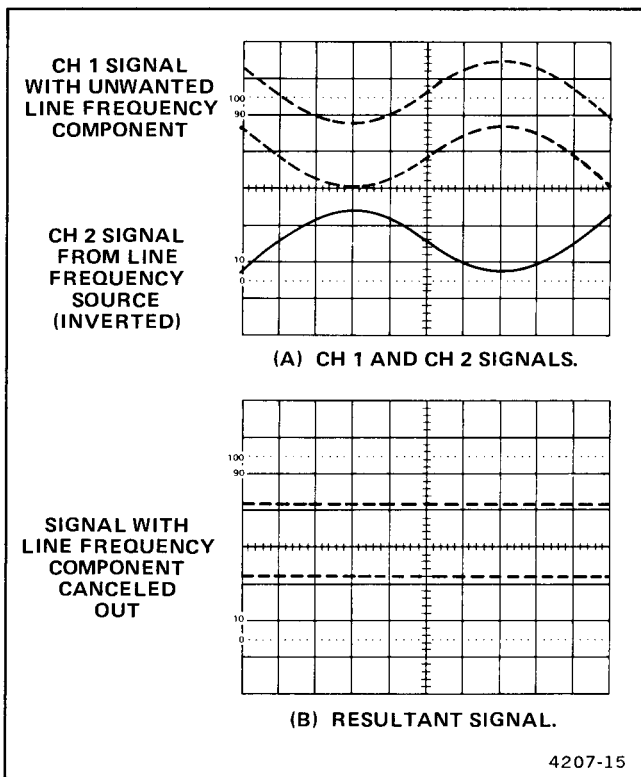

Figure 4-5. Common-mode rejection.

the same amplitude as the undesired portion of the Channel 1 display (see Figure 4-5A).

6. Select ADD VERTICAL MODE and slightly readjust the Channel 2 VOLTS/DIV Variable control for maximum cancellation of the undesired signal component (see Figure 4-5B).

Time Duration

To measure time between two points on a waveform, use the following procedure:

1. Preset instrument controls and obtain a baseline trace.
2. Apply the signal to either vertical-channel input connector and set the VERTICAL MODE switch to display the channel used.
3. Adjust the A TRIGGER LEVEL control to obtain a stable display.
4. Set the A SEC/DIV switch to display one complete period of the waveform. Ensure that the A and B SEC/DIV Variable control is in the CAL detent.
5. Position the display to place the time-measurement points on the center horizontal graticule line (see Figure 4-6).

6. Measure the horizontal distance between the time-measurement points.

7. Calculate time duration, using the following formula:

$$\text{Time Duration} = \frac{\text{horizontal distance (divisions)} \times \text{A SEC/DIV switch setting}}{\text{magnification factor}}$$

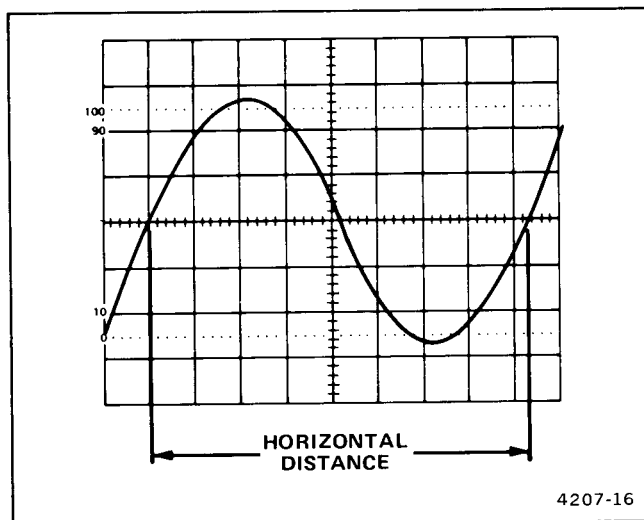

Figure 4-6. Time duration.

EXAMPLE: The distance between the time-measurement points is 8.3 divisions (see Figure 4-6), and the A SEC/DIV switch is set to 2 ms. The X10 Magnifier switch is pushed in (1X magnification).

Substituting the given values:

$$\text{Time Duration} = 8.3 \text{ div} \times 2 \text{ ms/div} = 16.6 \text{ ms}$$

Frequency

The frequency of a recurrent signal can be determined from its time-duration measurement as follows:

1. Measure the time duration of one waveform cycle using the preceding "Time Duration" measurement procedure.
2. Calculate the reciprocal of the time-duration value to determine the frequency of the waveform.

EXAMPLE: The signal in Figure 4-6 has a time duration of 16.6 ms.

Calculating the reciprocal of time duration:

$$\text{Frequency} = \frac{1}{\text{time duration}} = \frac{1}{16.6 \text{ ms}} = 60 \text{ Hz}$$

Rise Time

Rise-time measurements use the same methods as time duration, except that the measurements are made between the 10% and 90% points on the leading edge of the waveform (see Figure 4-7). Fall time is measured between the 90% and 10% points on the trailing edge of the waveform.

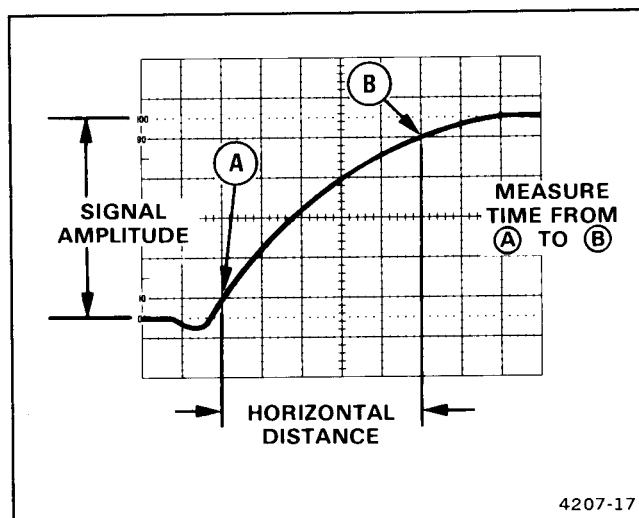

Figure 4-7. Rise time.

1. Preset instrument controls and obtain a baseline trace.

2. Apply an exact 5-division signal to either vertical-channel input connector and set the VERTICAL MODE switch to display the channel used. Ensure that the VOLTS/DIV Variable control is in the CAL detent.

NOTE

For rise time greater than 0.2 μs, the VOLTS/DIV Variable control may be used to obtain an exact 5-division display.

3. Set the A TRIGGER SLOPE switch to OUT: \lrcorner . Use a sweep-speed setting that displays several complete cycles or events (if possible).

4. Adjust vertical positioning so that the zero reference of the waveform touches the 0% graticule line and the top of the waveform touches the 100% graticule line (see Figure 4-7).

5. Set the A SEC/DIV switch for a single-waveform display, with the rise time spread horizontally as much as possible.

6. Horizontally position the display so the 10% point on the waveform intersects the second vertical graticule line (see Figure 4-7, Point A).

Operating Procedures—2235 Operators

7. Measure the horizontal distance between the 10% and 90% points and calculate the time duration using the following formula:

$$\text{Rise Time} = \frac{\text{horizontal distance (divisions)} \times \text{A SEC/DIV switch setting}}{\text{magnification factor}}$$

EXAMPLE: The horizontal distance between the 10% and 90% points is 5 divisions (see Figure 4-7), and the A SEC/DIV switch is set to 1 μs . The X10 magnifier knob is pushed in (1X magnification).

Substituting the given values in the formula:

$$\text{Rise Time} = \frac{5 \text{ div} \times 1 \mu\text{s/div}}{1} = 5 \mu\text{s}$$

Time Difference Between Two Time-Related Pulses

The calibrated sweep speed and dual-trace features of the 2235 allow measurement of the time difference between two separate events. To measure time difference, use the following procedure:

1. Preset instrument controls and obtain a baseline trace.

2. Set the A TRIGGER SOURCE switch to CH 1.

3. Set both AC-GND-DC switches to the same position, depending on the type of input coupling desired.

4. Using either probes or cables with equal time delays, connect a known reference signal to the Channel 1 input and the comparison signal to the Channel 2 input.

5. Set both VOLTS/DIV switches for 4- or 5-division displays.

6. Select BOTH VERTICAL MODE; then select either ALT or CHOP, depending on the frequency of input signals.

7. If the two signals are of opposite polarity, press in the Channel 2 INVERT push button to invert the Channel 2 display (signals may be of opposite polarity due to 180° phase difference; if so, note this for use later in the final calculation).

8. Adjust the A TRIGGER LEVEL control for a stable display.

9. Set the A SEC/DIV switch to a sweep speed which provides three or more divisions of horizontal separation between the reference points on the two displays. Center each of the displays vertically (see Figure 4-8).

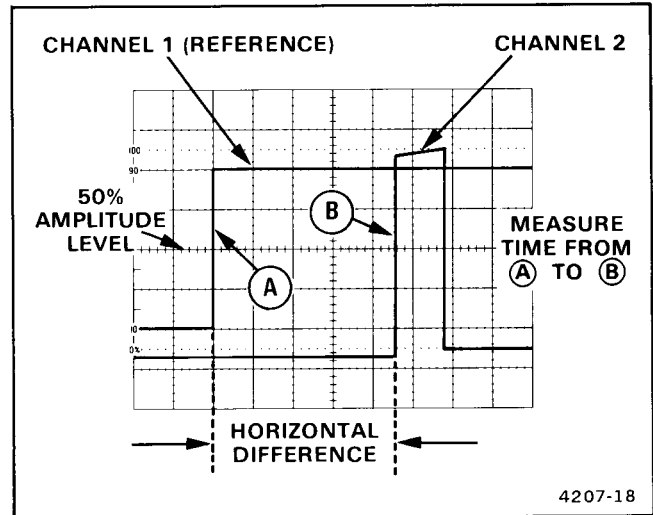

Figure 4-8. Time difference between two time-related pulses.

10. Measure the horizontal difference between the two signal reference points and calculate the time difference using the following formula:

$$\text{Time Difference} = \frac{\text{A SEC/DIV switch setting} \times \text{horizontal difference (divisions)}}{\text{magnification factor}}$$

EXAMPLE: The A SEC/DIV switch is set to 50 μs , the X10 magnifier knob is pulled out, and the horizontal difference between waveform measurement points is 4.5 divisions.

Substituting the given values in the formula:

$$\text{Time Difference} = \frac{50 \mu\text{s/div} \times 4.5 \text{ div}}{10} = 22.5 \mu\text{s}$$

Phase Difference

In a similar manner to "Time Difference," phase comparison between two signals of the same frequency can be made using the dual-trace feature of the 2235. This method

of phase difference measurement can be used up to the frequency limit of the vertical system. To make a phase comparison, use the following procedure:

1. Preset instrument controls and obtain a baseline trace, then set the A TRIGGER SOURCE switch to CH 1.
2. Set both AC-GND-DC switches to the same position, depending on the type of input coupling desired.
3. Using either probes or coaxial cables with equal time delays, connect a known reference signal to the Channel 1 input and the unknown signal to the Channel 2 input.
4. Select BOTH VERTICAL MODE; then select either ALT or CHOP, depending on the frequency of the input signals. The reference signal should precede the comparison signal in time.
5. If the two signals are of opposite polarity, press in the Channel 2 INVERT push button to invert the Channel 2 display.
6. Set both VOLTS/DIV switches and both Variable controls so the displays are equal in amplitude.
7. Adjust the A TRIGGER LEVEL control for a stable display.
8. Set the A SEC/DIV switch to a sweep speed which displays about one full cycle of the waveforms.
9. Position the displays and adjust the SEC/DIV Variable control so that one reference-signal cycle occupies exactly 8 horizontal graticule divisions at the 50% rise-time points (see Figure 4-9). Each division of the graticule now represents 45° of the cycle ($360^\circ \div 8$ divisions), and the horizontal graticule calibration can be stated as 45° per division.
10. Measure the horizontal difference between corresponding points on the waveforms at a common horizontal graticule line (50% of rise time) and calculate the phase difference using the following formula:

$$\text{Phase Difference} = \text{horizontal difference (divisions)} \times \text{horizontal graticule calibration (deg/div)}$$

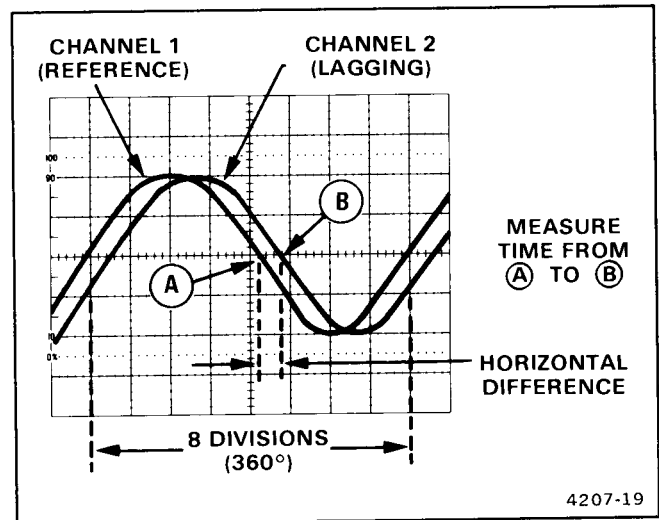

Figure 4-9. Phase difference.

EXAMPLE: The horizontal difference is 0.6 division with a graticule calibration of 45° per division as shown in Figure 4-9.

Substituting the given values into the phase difference formula:

$$\text{Phase Difference} = 0.6 \text{ div} \times 45^\circ/\text{div} = 27^\circ$$

More accurate phase measurements can be made by using the X10 Magnifier function to increase the sweep speed without changing the SEC/DIV Variable control setting.

EXAMPLE: If the sweep speed were increased 10 times with the magnifier (X10 Magnifier out), the magnified horizontal graticule calibration would be $45^\circ/\text{division}$ divided by 10 (or $4.5^\circ/\text{division}$). Figure 4-10 shows the same signals illustrated in Figure 4-9, but magnifying the displays results in a horizontal difference of 6 divisions between the two signals.

Substituting the given values in the phase difference formula:

$$\text{Phase Difference} = 6 \text{ div} \times 4.5^\circ/\text{div} = 27^\circ$$

Amplitude Comparison

In some applications it may be necessary to establish a set of deflection factors other than those indicated by the VOLTS/DIV switch settings. This is useful for comparing unknown signals to a reference signal of known amplitude. To accomplish this, a reference signal of known

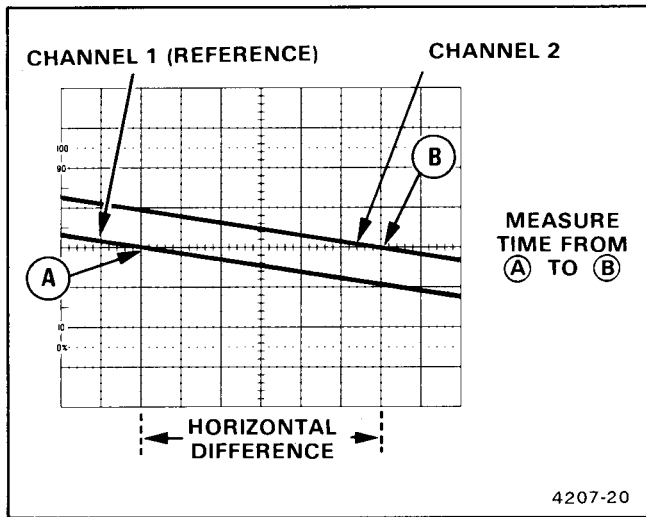

Figure 4-10. High-resolution phase difference.

amplitude is first set to an exact number of vertical divisions by adjusting the VOLTS/DIV switch and Variable control. Unknown signals can then be quickly and accurately compared with the reference signal without disturbing the setting of the VOLTS/DIV Variable control. The procedure is as follows.

1. Preset instrument controls and obtain a baseline trace.

2. Apply the reference signal to either vertical channel input and set the VERTICAL MODE switch to display the channel used.

3. Set the amplitude of the reference signal to an exact number of vertical divisions by adjusting the VOLTS/DIV switch and VOLTS/DIV Variable control.

4. Establish a vertical conversion factor, using the following formula (reference signal amplitude must be known):

$$\text{Vertical Conversion Factor} = \frac{\text{reference signal amplitude (volts)}}{\text{vertical deflection (divisions)} \times \text{VOLTS/DIV switch setting}}$$

5. Disconnect the reference signal and apply the unknown signal to be measured to the same channel input. Adjust the VOLTS/DIV switch to a setting that provides sufficient vertical deflection to make an accurate measurement. Do not readjust the VOLTS/DIV Variable control.

6. Establish an arbitrary deflection factor, using the following formula:

$$\text{Arbitrary Deflection Factor} = \frac{\text{vertical conversion factor}}{\text{VOLTS/DIV switch setting}}$$

7. Measure the vertical deflection of the unknown signal in divisions and calculate its amplitude using the following formula:

$$\text{Unknown Signal Amplitude} = \text{arbitrary deflection factor} \times \text{vertical deflection (divisions)}$$

EXAMPLE: The reference signal amplitude is 30 V, with a VOLTS/DIV switch setting of 5 and the VOLTS/DIV Variable control adjusted to provide a vertical deflection of exactly 4 divisions.

Substituting these values in the vertical conversion factor formula:

$$\text{Vertical Conversion Factor} = \frac{30 \text{ V}}{4 \text{ div} \times 5 \text{ V/div}} = 1.5$$

Continuing, for the unknown signal the VOLTS/DIV switch setting is 1, and the peak-to-peak amplitude spans five vertical divisions. The arbitrary deflection factor is then determined by substituting values in the formula:

$$\text{Arbitrary Deflection Factor} = 1.5 \times 1 \text{ V/div} = 1.5 \text{ V/div}$$

The amplitude of the unknown signal can then be determined by substituting values in the unknown signal amplitude formula:

$$\text{Amplitude} = 1.5 \text{ V/div} \times 5 \text{ div} = 7.5 \text{ V}$$

Time Comparison

In a similar manner to "Amplitude Comparison," repeated time comparisons between unknown signals and a reference signal (e.g., on assembly line test) may be easily and accurately measured with the 2235. To accomplish this, a reference signal of known time duration is first set to an exact number of horizontal divisions by adjusting the A SEC/DIV switch and the SEC/DIV Variable control. Unknown signals can then be compared with the reference signal without disturbing the setting of the SEC/DIV Variable control. The procedure is as follows:

1. Set the time duration of the reference signal to an exact number of horizontal divisions by adjusting the A SEC/DIV switch and the SEC/DIV Variable control.

2. Establish a horizontal conversion factor, using the following formula (reference signal time duration must be known):

$$\text{Horizontal Conversion Factor} = \frac{\text{reference signal time duration (seconds)}}{\text{horizontal distance (divisions)} \times \text{A SEC/DIV switch setting}}$$

3. For the unknown signal, adjust the A SEC/DIV switch to a setting that provides sufficient horizontal deflection to make an accurate measurement. Do not readjust the SEC/DIV Variable control.

4. Establish an arbitrary deflection factor, using the following formula:

$$\text{Arbitrary Deflection Factor} = \text{horizontal conversion factor} \times \text{A SEC/DIV switch setting}$$

5. Measure the horizontal distance of the unknown signal in divisions and calculate its time duration using the following formula:

$$\text{Time Duration} = \text{arbitrary deflection factor} \times \text{horizontal distance (divisions)}$$

6. Frequency of the unknown signal can then be determined by calculating the reciprocal of its time duration.

EXAMPLE: The reference signal time duration is 2.19 ms, the A SEC/DIV switch setting is 0.2 ms, and the SEC/DIV Variable control is adjusted to provide a horizontal distance of exactly 8 divisions.

Substituting the given values in the horizontal conversion factor formula:

$$\text{Horizontal Conversion Factor} = \frac{2.19 \text{ ms}}{8 \text{ div} \times 0.2 \text{ ms/div}} = 1.37$$

Continuing, for the unknown signal the A SEC/DIV switch setting is 50 μs, and one complete cycle spans 7

horizontal divisions. The arbitrary deflection factor is then determined by substituting values in the formula:

$$\text{Arbitrary Deflection Factor} = 1.37 \times 50 \mu\text{s/div} = 68.5 \mu\text{s/div}$$

The time duration of the unknown signal can then be computed by substituting values in the formula:

$$\text{Time Duration} = 68.5 \mu\text{s/div} \times 7 \text{ div} = 480 \mu\text{s}$$

The frequency of the unknown signal is then calculated:

$$\text{Frequency} = \frac{1}{480 \mu\text{s}} = 2.083 \text{ kHz}$$

TV Line Signal



The following procedure is used to display a TV Line signal.

1. Preset instrument controls and select NORM/TV LINE A TRIGGER Mode.

2. Apply the TV signal to either vertical-channel input connector and set the VERTICAL MODE switch to display the channel used.

3. Set the appropriate VOLTS/DIV switch to display 0.3 division or more of composite video signal.

4. Set the A SEC/DIV switch to 10 μs.

5. Set the A TRIGGER SLOPE switch to either OUT:  (for positive-going TV signal sync pulses) or IN:  (for negative-going TV signal sync pulses).

NOTE

To examine a TV Line signal in more detail, either the X10 Magnifier or the Delayed-Sweep Magnification feature may be used.

TV Field Signal

The television feature of the 2235 can also be used to display TV Field signals.

1. Preset instrument controls and obtain a baseline trace.

2. Set the A TRIGGER Mode switch to TV FIELD (P-P AUTO and NORM/TV LINE buttons both pushed in) and set the A SEC/DIV switch to 2 ms.

3. To display a single field, connect the TV signal to either vertical-channel input connector and set the VERTICAL MODE switch to display the channel used.

4. Set the appropriate VOLTS/DIV switch to display 2.5 divisions or more of composite video signal.

5. Set the A TRIGGER SLOPE switch to either OUT: \int (for positive-going TV signal sync pulses) or IN: \searrow (for negative-going TV signal sync pulses).

6. To change the field that is displayed, momentarily interrupt the trigger signal by setting the AC-GND-DC switch to GND and then back to AC until the desired field is displayed.

NOTE

To examine a TV Field signal in more detail, either the X10 Magnifier or the Delayed-Sweep Magnification feature may be used.

7. To display a selected horizontal line, first trigger the sweep on a vertical (field) sync pulse, then use the "Magnified Sweep Runs After Delay" procedure in this part (steps 5 through 7) to magnify the selected horizontal line for a closer examination. This procedure is useful for examining Vertical Interval Test Signals (VITS).

8. To display either Field 1 or Field 2 individually, connect the TV signal to both CH 1 and CH 2 input connectors and select BOTH and ALT VERTICAL MODE.

9. Set the A SEC/DIV switch to a faster sweep speed (displays of less than one full field). This will synchronize Channel 1 display to one field and Channel 2 to the other field.

DELAYED-SWEEP MAGNIFICATION

The delayed-sweep feature of the 2235 can be used to provide higher apparent magnification than is provided by the X10 Magnifier switch. Apparent magnification occurs as a result of displaying a selected portion of the A trace at a faster sweep speed (B Sweep speed). The A SEC/DIV switch setting determines how often the B trace will be

displayed. Since the B Sweep can occur only once for each A Sweep, the A Sweep time duration sets the amount of time elapse between succeeding B Sweeps.

The intensified zone is an indication of both the location and length of the B Sweep interval within the A Sweep interval. Positioning of the intensified zone (i.e., setting the amount of time between start of the A Sweep and start of the B Sweep) is accomplished with the B DELAY TIME POSITION control. With either ALT or B HORIZONTAL MODE selected, the B DELAY TIME POSITION control provides continuously variable positioning of the start of the B Sweep. The range of this control is sufficient to place the B Sweep interval at any location within the A Sweep interval. When ALT HORIZONTAL MODE is selected, the B SEC/DIV switch setting determines the B Sweep speed and concurrently sets the length of the intensified zone on the A trace.

Using delayed-sweep magnification may produce a display with some slight horizontal movement (pulse jitter). Pulse jitter includes not only the inherent uncertainty of triggering the delayed sweep at exactly the same trigger point each time, but also jitter that may be present in the input signal. If pulse jitter needs to be measured, use the "Pulse Jitter Time Measurement" procedure which follows the discussion of "Magnified Sweep Runs After Delay."

Magnified Sweep Runs After Delay

The following procedure explains how to operate the B Sweep in a nontriggered mode and to determine the resulting apparent magnification factor.

1. Preset instrument controls and obtain a baseline trace.

2. Apply the signal to either vertical channel input connector and set the VERTICAL MODE switch to display the channel used.

3. Set the appropriate VOLTS/DIV switch to produce a display of approximately 2 or 3 divisions in amplitude and center the display.

4. Set the A SEC/DIV switch to a sweep speed which displays at least one complete waveform cycle.

5. Select ALT HORIZONTAL MODE. Adjust both the appropriate channel POSITION control and the A/B SWP SEP control to display the A trace above the B trace.

6. Adjust the B DELAY TIME POSITION control to position the start of the intensified zone to the portion of the display to be magnified (see Figure 4-11).

7. Set the B SEC/DIV switch to a setting which intensifies the full portion of the A trace to be magnified. The intensified zone will be displayed as the B trace (see Figure 4-11). The B HORIZONTAL MODE may also be used to magnify the intensified portion of the A Sweep.

8. The apparent sweep magnification can be calculated from the following formula:

$$\frac{\text{Apparent Delayed Sweep Magnification}}{\text{}} = \frac{\text{A SEC/DIV switch setting}}{\text{B SEC/DIV switch setting}}$$

EXAMPLE: Determine the apparent magnification of a display with an A SEC/DIV switch setting of 0.1 ms and a B SEC/DIV switch setting of 1 μ s.

Substituting the given values:

$$\text{Apparent Magnification} = \frac{1 \times 10^{-4} \text{ s}}{1 \times 10^{-6} \text{ s}} = 10^2 = 100$$

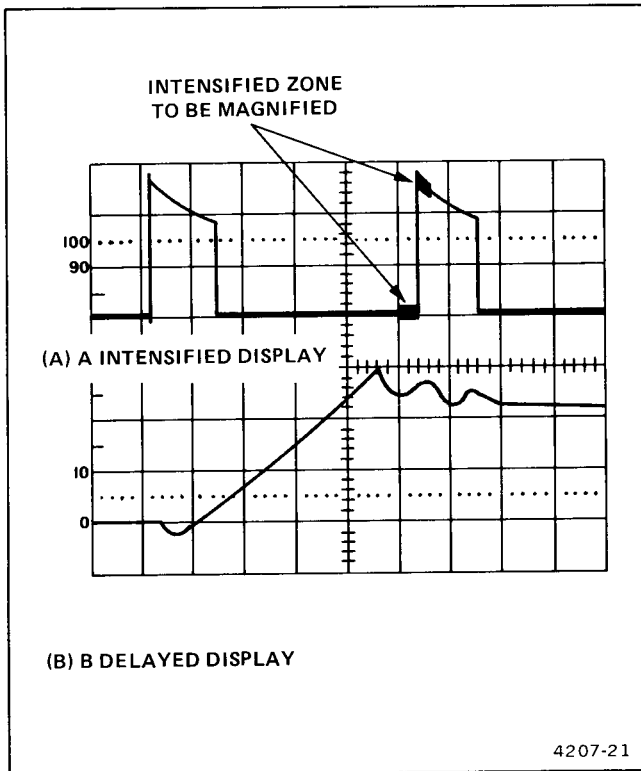

Figure 4-11. Delayed-sweep magnification.

Pulse Jitter Time Measurement

To measure pulse jitter time:

1. Perform steps 1 through 7 of the preceding "Magnified Sweep Runs After Delay" procedure.

2. Referring to Figure 4-12, measure the difference between Point A and Point B in divisions and calculate the pulse jitter time using the following formula:

$$\text{Pulse Jitter Time} = \frac{\text{horizontal difference (divisions)}}{\text{B SEC/DIV switch setting}}$$

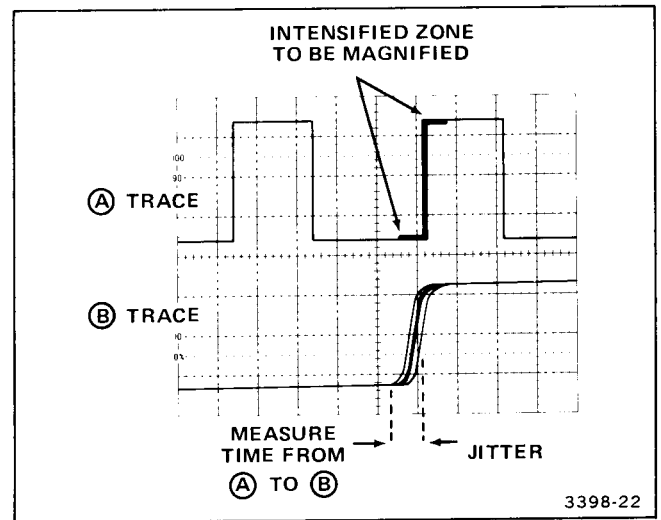

Figure 4-12. Pulse jitter.

Triggered Magnified Sweep

The following procedure explains how to operate the B Sweep in a triggered mode and to determine the resulting apparent magnification factor. Operating the B Sweep in a triggered mode provides a more stable display, since the delayed display is triggered at the same point each time.

1. Perform steps 1 through 7 of the preceding "Magnified Sweep Runs After Delay" procedure.

NOTE

The intensified zone seen in the ALT HORIZONTAL MODE display will move from trigger point to trigger point as the B DELAY TIME POSITION control is rotated.

2. Adjust the B TRIGGER LEVEL control so the intensified zone on the A trace is stable.

3. The apparent magnification factor can be calculated from the formula shown in step 8 of the "Magnified Sweep Runs After Delay" procedure.

DELAYED-SWEEP TIME MEASUREMENTS

Operating the 2235 Oscilloscope with HORIZONTAL MODE set to either ALT or B will permit time measurements to be made with a greater degree of accuracy than attained with HORIZONTAL MODE set to A. The following procedures describe how these measurements are accomplished.

Time Difference Between Repetitive Pulses

1. Preset instrument controls and obtain a baseline trace.

2. Apply the signal to either vertical-channel input connector and set the VERTICAL MODE switch to display the channel used.

3. Set the appropriate VOLTS/DIV switch to produce a display of approximately 2 or 3 divisions in amplitude.

4. Set the A SEC/DIV switch to display the measurement points of interest within the graticule area.

5. Select ALT HORIZONTAL MODE and adjust both the appropriate channel POSITION control and A/B SWP SEP control to display the A trace above the B trace.

6. For the most accurate measurement, set the B SEC/DIV switch to the fastest sweep speed that provides a useable (visible) intensified zone.

7. Adjust the B DELAY TIME POSITION control to move the intensified zone to the leading edge of the first pulse (on the A trace); then fine adjust until the rising portion (on the B trace) is centered at any convenient vertical graticule line (see Figure 4-13).

8. Record the B DELAY TIME POSITION control dial setting.

9. Adjust the B DELAY TIME POSITION control clockwise to move the intensified zone to the leading edge

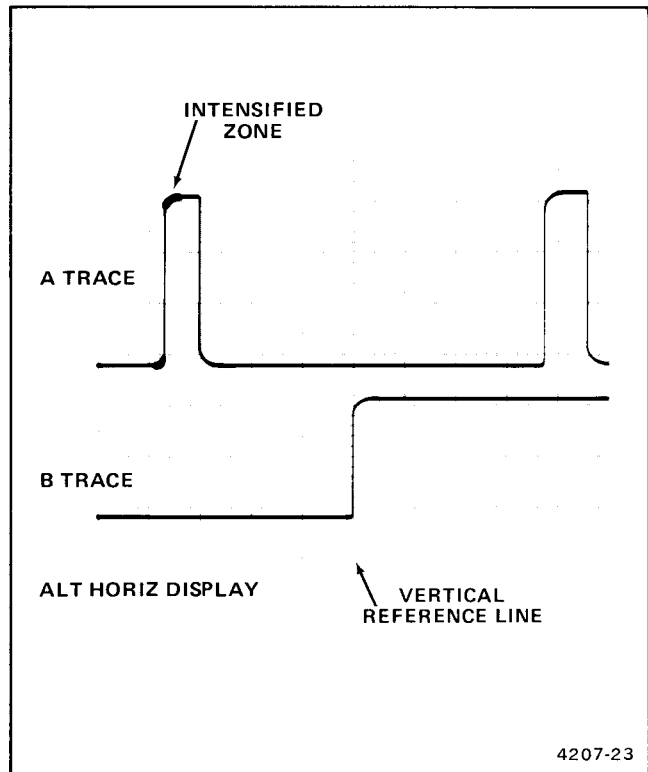

Figure 4-13. Time difference between repetitive pulses.

of the second pulse (on the A trace); then fine adjust until the rising portion (on the B trace) is centered at the same convenient vertical graticule used in preceding step 7.

10. Record the B DELAY TIME POSITION control dial setting.

11. Calculate the time difference between repetitive pulses using the following formula.

$$\text{Time Difference (Duration)} = \left(\begin{array}{c} \text{second} \\ \text{dial} \\ \text{setting} \end{array} - \begin{array}{c} \text{first} \\ \text{dial} \\ \text{setting} \end{array} \right) \left(\begin{array}{c} \text{A SEC/DIV} \\ \text{switch} \\ \text{setting} \end{array} \right)$$

EXAMPLE: With the A SEC/DIV switch set to 0.2 ms, the first B DELAY TIME POSITION dial setting is 1.20 and the second B DELAY TIME POSITION dial setting is 9.53 (see Figure 4-14).

Substituting the given values in the time difference formula:

$$\text{Time Difference} = (9.53 - 1.20) (0.2 \text{ ms}) = 1.666 \text{ ms}$$

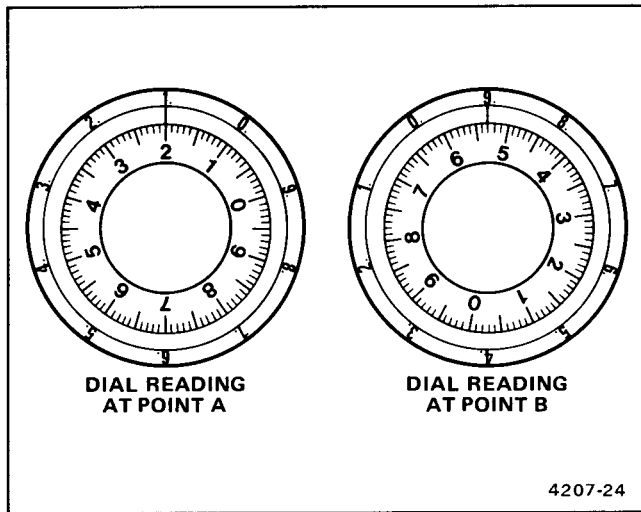

Figure 4-14. B DELAY TIME POSITION control settings.

Rise Time

The measurement method for rise time is the same as for time difference between repetitive pulses, except that the measurements are made between the 10% and 90% points on the leading edge of the waveform. Fall time is measured between the 90% and 10% points on the trailing edge of the waveform.

1. Preset instrument controls and obtain a baseline trace.
2. Apply a 5-division signal to either vertical-channel input connector and set the VERTICAL MODE switch to display the channel used. Ensure that the VOLTS/DIV Variable control is in the CAL detent.

NOTE

For rise time less than 0.2 μ s per division, the VOLTS/DIV Variable control may be used to obtain an exact 5-division display.

3. Vertically position the trace so that the zero reference of the waveform touches the 0% graticule line and the top of the waveform touches the 100% graticule line (see Figure 4-15).

4. Set the A SEC/DIV switch for a single-waveform display. Ensure that the A and B SEC/DIV Variable control is in the CAL detent.

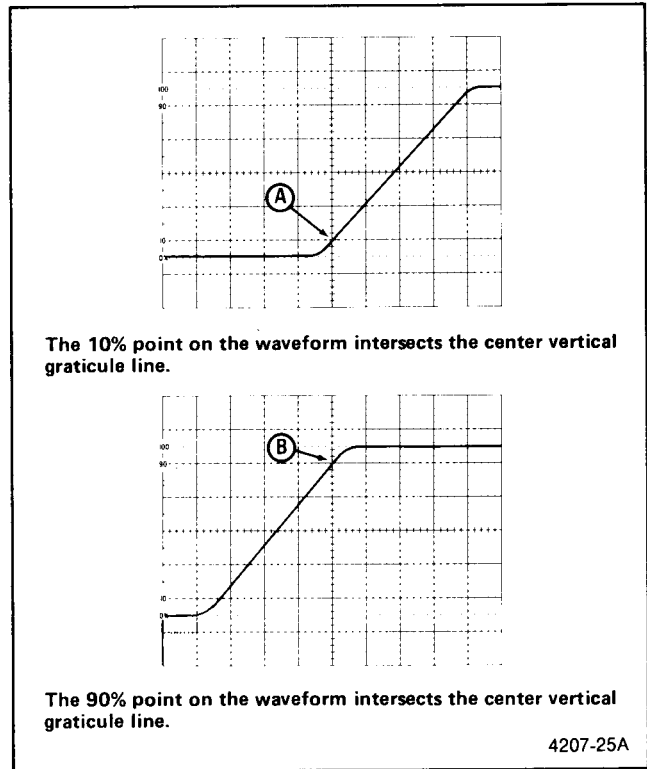

Figure 4-15. Rise time, differential time method.

5. Select ALT HORIZONTAL MODE and set the B SEC/DIV switch to spread the rise-time-measurement portion of the display as much as possible.
6. Select the B HORIZONTAL MODE. Adjust the B DELAY TIME POSITION control until the display intersects the 10% point at the center vertical graticule line (see Figure 4-15, Point A).
7. Record the B DELAY TIME POSITION control dial setting.
8. Adjust the B DELAY TIME POSITION control until the display intersects the 90% point at the center vertical graticule line (see Figure 4-15, Point B).
9. Record the B DELAY TIME POSITION control dial setting.
10. Calculate rise time using the same formula listed in the "Time Difference Between Repetitive Pulses" measurement procedure.

Operating Procedures—2235 Operators

EXAMPLE: With the A SEC/DIV switch set to $1 \mu\text{s}$, the first B DELAY TIME POSITION dial setting (Point A) is 2.50 and the second B DELAY TIME POSITION dial setting (Point B) is 7.50.

Substituting the given values in the time difference formula:

$$\text{Rise Time} = (7.50 - 2.50) (1 \mu\text{s}) = 5 \mu\text{s}$$

Time Difference Between Two Time-Related Pulses

1. Preset instrument controls and obtain a baseline trace.

2. Using probes or cables having equal time delays, apply the reference signal to the Channel 1 input and apply the comparison signal to the Channel 2 input.

3. Set both VOLTS/DIV switches to produce a display of either 2 or 3 divisions in amplitude.

4. Select BOTH VERTICAL MODE and either ALT or CHOP, depending on the frequency of the input signals.

5. Set the A SEC/DIV switch to display the measurement points of interest within the graticule area.

6. Select ALT HORIZONTAL MODE and CH 1 VERTICAL MODE. Adjust both the Channel 1 POSITION control and the A/B SWP SEP control so that the A trace is displayed above the B trace.

7. Rotate the B DELAY TIME POSITION control to move the intensified zone to the rising edge of the reference pulse (on the A trace); then fine adjust until the rising portion (on the B trace) is centered at any convenient vertical graticule line (see Figure 4-16, point A).

8. Record the B DELAY TIME POSITION control dial setting.

9. Select CH 2 VERTICAL MODE and adjust both the Channel 2 POSITION control and the A/B SWP SEP control as necessary to display the A trace above the B trace.

10. Rotate the B DELAY TIME POSITION control to set the rising portion of the Channel 2 pulse (on the B

trace) to the same vertical reference point as used in preceding step 7 (see Figure 4-16, Point B). Observe the A trace to position the intensified zone to the correct pulse (if more than one pulse is displayed). Do not change the setting of the Horizontal POSITION control.

11. Record the B DELAY TIME POSITION control dial setting.

12. Calculate the time difference between the Channel 1 and Channel 2 pulses as in the preceding "Time Difference Between Repetitive Pulses" measurement procedure.

EXAMPLE: With the A SEC/DIV switch set to $50 \mu\text{s}$, the dial reading for the reference pulse (Channel 1) is 2.60 and the dial reading for the comparison pulse (Channel 2) is 7.10.

Substituting the given values into the time-difference (or duration) formula:

$$\text{Time Difference} = (7.10 - 2.60) (50 \mu\text{s}) = 225 \mu\text{s}$$

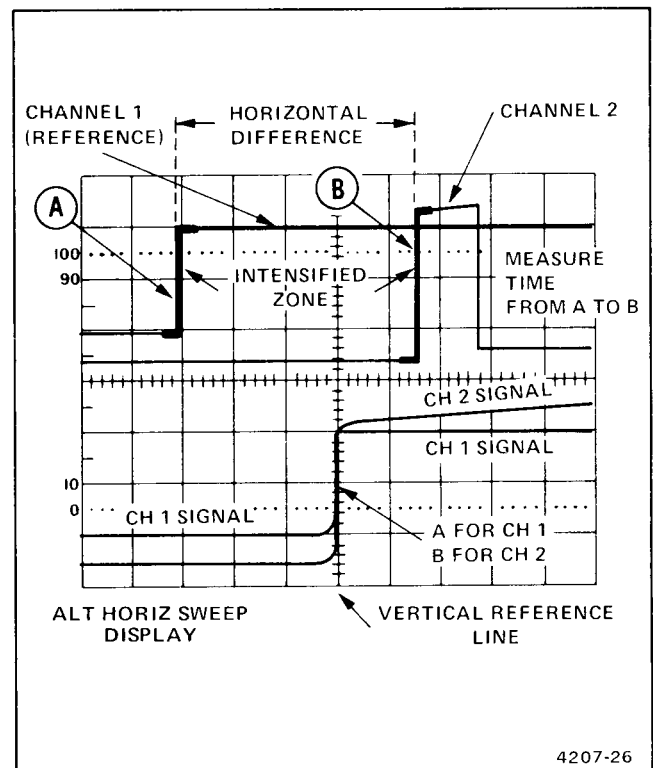

Figure 4-16. Time difference between two time-related pulses, differential time method.

OPTIONS AND ACCESSORIES

INTRODUCTION

This section contains a general description of available instrument options. Also included is a list of standard accessories included with each instrument and a partial list of optional accessories. Additional information about instrument options, option availability, and other accessories can be obtained either by consulting the current Tektronix Product Catalog or by contacting your Tektronix Field Office or representative.

Option 02

Option 02 provides a protective front panel cover for the instrument and also includes an accessory pouch for carrying probes and documentation.

Option 33

Option 33 is the Travel Line Package which adds extra instrument protection for use in rough environments. This package provides protection from impacts along the front and rear of the instrument. The rear bumper provides a wider base to set the instrument on which reduces the potential of tip-over when standing vertically. A protective front panel cover and an accessory pouch for carrying probes and documentation are included, plus a carrying strap for transporting and hands free operation.

POWER CORD OPTIONS

Instruments are shipped with the detachable power-cord configuration ordered by the customer. Descriptive information about the international power-cord optional is provided in Section 2, "Preparation for Use". The following list identifies the available power cords.

Option A1	Universal Euro 220 V, 50 Hz
Option A2	UK 240 V, 50 Hz
Option A3	Australian 240 V, 50 Hz
Option A4	North American 240 V, 60 Hz
Option A5	Switzerland 220 V, 50 Hz

STANDARD ACCESSORIES

The following standard accessories are provided with each instrument.

Qty	Description	Part Number
2	Probes, 10X, 1.5-m w/accessories	P6122
1	Operators Manual	070-4207-00

OPTIONAL ACCESSORIES

The following optional accessories are recommended for use with the 2235 Oscilloscope.

Description	Part Number
Service Manual	070-4206-00
Protective Front-Panel Cover	200-2520-00
Cord Wrap and Storage Pouch	016-0677-02
Protective Front-Panel Cover, Cord Wrap and Storage Pouch	020-0672-02
Probe Accessories, Grabber Tips	013-0191-00
Low-Cost, General-Purpose Camera	C-5C Option 04
Portable Instrument Cart	K212
Rack-Mounting Adapter Kit	016-0466-00
Carrying Strap	346-0199-00
Carrying Case	016-0792-01
Protective Rain Cover	016-0848-02

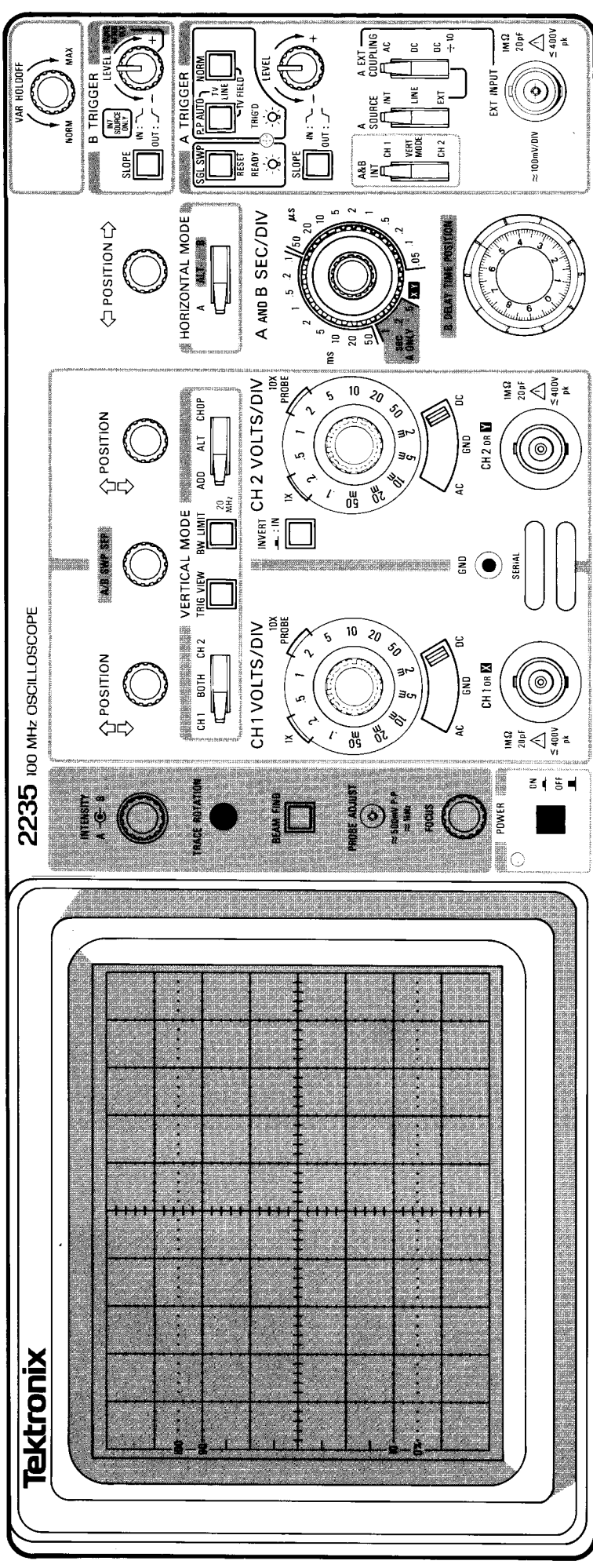

4207-27

Copyright © 1982, Tektronix, Inc.
All rights reserved.

Limited license: Tektronix, Inc. grants permission to reproduce this drawing as a visual aid for use in instrument operator training.

Tektronix, Inc.
P.O. Box 500, DS 39/199
Beaverton, Oregon 97077

MANUAL CHANGE INFORMATION

At Tektronix, we continually strive to keep up with latest electronic developments by adding circuit and component improvements to our instruments as soon as they are developed and tested.

Sometimes, due to printing and shipping requirements, we can't get these changes immediately into printed manuals. Hence, your manual may contain new change information on following pages.

A single change may affect several sections. Since the change information sheets are carried in the manual until all changes are permanently entered, some duplication may occur. If no such change pages appear following this page, your manual is correct as printed.

Date: 5-26-88

Change Reference: M66862

Product: 2235 OPERATORS

Manual Part No.: 070-4207-00

DESCRIPTION

Product Group 46

The Standard Test Probes for your instrument have been replaced with the P6109 Test Probes. Please note this change in the Standard Accessories List in this manual.

**WIND POWER CORD TIGHT, THEN
POSITION MALE RECEPTICAL IN
RECESSED AREA OF REAR PANEL**

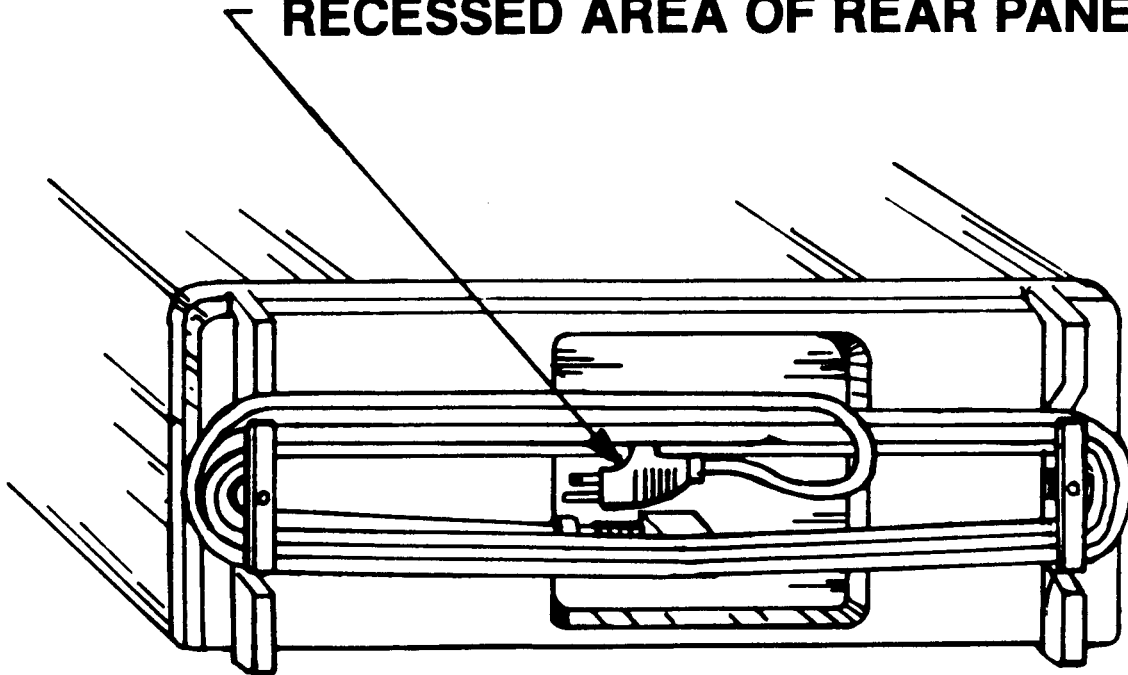

2200 SERIES POWER CORD WRAP

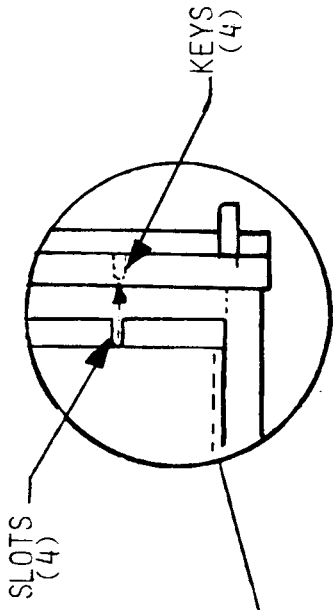

FIG - 2

POUCH MOUNTING - (2200 INST)

1. POUCH IS MOUNTED ON TOP, SECURED BY THE TWO END PANELS
2. POUCH CAN BE MOUNTED BY ARCHING THE POUCH & SLIDING THE TWO ENDS UNDER THE REAR & FRONT PANELS. (SEE FIG - 1)
3. WHEN POUCH IS SECURED PROPERLY THE (4) SLOTS IN THE METAL POUCH PLATE WILL MATE WITH THE (4) KEYS INSIDE THE FRONT & REAR PANELS (SEE FIG - 3)

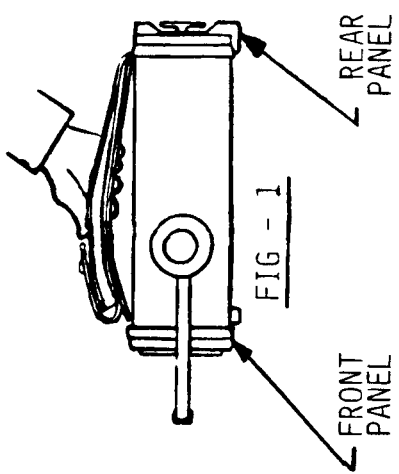

FIG - 1

FRONT PANEL

REAR PANEL