



MC2000B, MC2000B-EC

Optical Chopper

User Guide



















Table of Contents

Chapter 1	Warning Symbol Definitions	1
Chapter 2	Safety Warnings	2
Chapter 3	Description.....	3
	3.1. Product Overview.....	3
	3.2. Chopper Blades.....	4
	3.3. Front Panel Description.....	6
	3.4. Rear Panel Description	6
Chapter 4	Setup	7
Chapter 5	Basic Operation.....	8
	5.1. Internal Reference Operating Mode.....	8
	5.2. External Reference Operating Mode	8
	5.3. Reference-In Signal.....	9
	5.4. Reference-Out Signal.....	9
	5.5. On Cycle.....	10
Chapter 6	Advanced Operating Instructions.....	11
	6.1. Internal Frequency Synthesizer I.....	11
	6.1.1. Selecting the REFERENCE IN signal	11
	6.1.2. Selecting the REFERENCE OUT signal	11
	6.2. External Reference Mode	11
	6.2.1. Selecting the REFERENCE IN signal	11
	6.2.2. Selecting the REFERENCE OUT signal	11
	6.3. Harmonic Reference Generation	12
	6.3.1. Selecting the REFERENCE IN signal	12
	6.3.2. Setting the Sub-Harmonic.....	12
	6.3.3. Combining the Harmonic and Sub-Harmonic Modes	12
	6.3.4. Selecting the REFERENCE OUT signal.....	12
	6.4. Two-Frequency Chopping	13
	6.4.1. Selecting the REFERENCE IN signal	13
	6.4.2. Selecting the REFERENCE OUT signal.....	13
	6.4.3. Setting the Chopping Speed in the Two Frequency Mode	13
	6.5. Higher Precision Blades	14
	6.5.1. Selecting the REFERENCE IN signal	14
	6.5.2. Selecting the REFERENCE OUT signal.....	14
	6.5.3. Master Slave Configuration.....	14
	6.6. Adjustable Duty Cycle Blade.....	15

Chapter 7	Remote Communications	16
	7.1. Installing the USB Drivers	16
	7.2. Command Line Interface	16
Chapter 8	Commands.....	17
	8.1. Commands and Queries	17
	8.2. Blade Indices	18
	8.3. Blade Dependent Reference Input.....	18
	8.4. Blade Dependent Reference Output.....	19
Chapter 9	Maintenance and Troubleshooting.....	20
	9.1. Cleaning	20
	9.2. Diagnostic Messages.....	20
Chapter 10	Fuse Replacement and Line Voltage Selection.....	21
	10.1. Materials Needed.....	21
	10.2. Fuse Replacement and Line Voltage Selection.....	21
Chapter 11	Visual Menu Structure	23
Chapter 12	Specifications	24
	12.1. Blade Specifications	24
	12.2. Performance Specifications	26
Chapter 13	Mechanical Drawing.....	28
	13.1. Console Dimension Drawing.....	28
	13.2. Chopper Head Dimension Drawing	29
Chapter 14	Regulatory.....	30
Chapter 15	Declaration of Conformity	31
Chapter 16	Thorlabs Worldwide Contacts.....	32

Chapter 1 Warning Symbol Definitions

Below is a list of warning symbols you may encounter in this manual or on your device.

Symbol	Description
	Direct Current
	Alternating Current
	Both Direct and Alternating Current
	Earth Ground Terminal
	Protective Conductor Terminal
	Frame or Chassis Terminal
	Equipotentiality
	On (Supply)
	Off (Supply)
	In Position of a Bi-Stable Push Control
	Out Position of a Bi-Stable Push Control
	Caution: Risk of Electric Shock
	Caution: Hot Surface
	Caution: Risk of Danger
	Warning: Laser Radiation
	Caution: Spinning Blades May Cause Harm

Chapter 2 Safety Warnings



Warning Electrical Shock



To avoid electrical shock the power cord protective grounding conductor must be connected to ground. Refer servicing to qualified personnel.

The unit must be powered off, unplugged from the AC input power source, and disconnected from all external devices before removing the cover and replacing the fuse. Failure to do so may cause serious injury to the user since high voltages exist within the unit.

Thorlabs provides the proper 120 VAC power input cable with each MC2000B for use in the United States, and the appropriate 230 VAC input cable with each MC2000B-EC for use in Europe. In the event the unit is used elsewhere, the user will need to supply a properly grounded power cable to power the unit. If something should go wrong with the unit, do not attempt to fix. Call a Thorlabs representative and arrange for repair. The unit should never be opened unless changing the fuse or line voltage as described in Section 5.

Thorlabs ships all MC2000B units configured to operate in the United States (i.e. line voltage 115 VAC, 60 Hz and 250 mA Slow Blo fuse installed), and all MC2000B-EC units to operate in Europe (i.e. line voltage 230 VAC, 50 Hz and 125 mA Slow Blo fuse installed).



Warning Rotating Blade!



Make sure the chopper wheel can spin unhampered. Keep any objects clear of the spinning wheel as this might damage the chopper. This device should not be used as a cutting tool. Keep body parts clear while the blade is spinning to prevent injuries. Spinning blade can cause skin abrasion or soft tissue removal. Turn the power off before servicing.



WARNING



When using high intensity light sources, use the appropriate Eye Protection required by the light sources being used.

Chapter 3 Description

3.1. Product Overview

The MC2000B Optical Chopper is a precision instrument that utilizes advanced features to create pulses of light from a continuous beam. This beam can be from a coherent or incoherent light source. The MC2000B is the enhanced version of the MC2000. It offers faster locking times, better graphics, and a larger selection of blades. The MC2000B uses a phased-locked loop (PLL) motor speed control design to accurately maintain the chopping speed as well as the phase of a reference signal. An internal, crystal-stabilized, frequency synthesizer provides an accurate and stable reference frequency for reliable, long-term performance.

Unlike conventional, open-loop speed control designs, the PLL speed control circuit also allows the MC2000B chopper to be synchronized to external reference signals. This includes other MC2000B choppers, and reference sources such as DSP lock-in amplifiers.

For more advanced measurements, the MC2000B locks to a harmonic, sub-harmonic, or fractional-harmonic of an external reference frequency. The onboard microprocessor multiplies the external reference up to the 15th harmonic, or divides the reference down to the 15th sub-harmonic. A fractional harmonic can be obtained by combining both the frequency multiplication and division together.

Additionally, the MC2000B supports two-frequency chopping from a single blade. Special (Inner/Outer) 4/7, 5/7, 3/30, 8/60, and 53/60 harmonic blades are available. These slot combinations split single beams for individual modulation in ratio metric experiments. Another example application is a pump-probe experiment where the pump beam is modulated at the outer frequency, and a probe beam is modulated at the inner frequency. The MC2000B provides the sum and difference frequencies of the two-frequency blades for accurate lock-in detection of the frequency-mixed response.

Note, on two-frequency blades, the chopper wheel reference derives from two photo-interrupters on the optical head that sense the motion of the chopper blade. A third set of slots on the rim of the blade are added, because the second photo-interrupter is unable to physically measure the inner slots. These slots match the inner slots in exact orientation and frequency.

The top two design elements responsible for this device's high precision are a high-quality DC motor with a rare earth magnet, and a photo-etched optical chopper wheel. The compact optical head has a wide base for extra stability. The base is slotted for two, 1/4"-20 mounting screws on 3" centers. The interface cable uses circular snap-on connectors for easy setup.

The MC2000B controller includes a 240 x 128 pixel graphics display for setting and monitoring the chopper's functions. All of the functions are accessible through a front panel knob with turn and push control. Multiple user setups can be easily saved and recalled from non-volatile memory. A USB interface is a standard feature for remote PC control of the MC2000B.

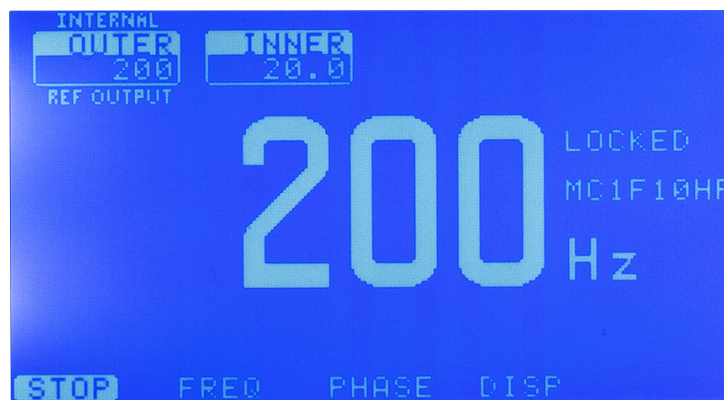

3.2. Chopper Blades

The tables below show the various available chopper blades for the MC2000B.





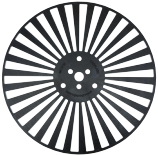
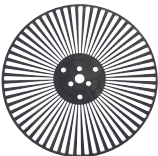
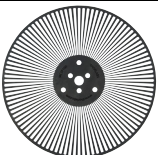





Photo	Item#	Slots	Frequency	Notes
High Precision Chopper Blades				
	MC1F2	2/100	4 Hz - 200 Hz	
	MC1F2P10	2/100	4 Hz - 200 Hz	Not compatible with the MC2000.
	MC1F10HP	10/100	20 Hz - 1 kHz	This blade is included with the MC2000B Not compatible with the MC2000.
Single Frequency Chopper Blades				
	MC1F10	10	20 Hz - 1 kHz	
	MC1F15	15	30 Hz - 1.5 kHz	
	MC1F30	30	60 Hz - 3 kHz	
	MC1F60	60	120 Hz - 6 kHz	
	MC1F100	100	200 Hz - 10 kHz	

Photo	Item#	Slots	Frequency	Notes
	MC1F6P10	6	12 Hz - 600 Hz	Not compatible with the MC2000.
	MC1F10A	10	20 Hz - 1 kHz	This blade has an adjustable Duty Cycle Not compatible with the MC2000.

Note

The Harmonic Frequency Chopper Blades are designed for the MC2000B Optical Chopper and **are not** supported by the MC2000!

Photo	Item#	Slots	Frequency	
			Inner Frequency	Outer Frequency
Harmonic Frequency Chopper Blades				
	MC2F47	4/7	8 Hz - 400 Hz	14 Hz - 700 Hz
	MC2F57B	5/7	10 Hz - 500 Hz	14 Hz - 700 Hz
	MC2F330	3/30	6 Hz - 300 Hz	60 Hz - 3 kHz
	MC2F860	8/60	16 Hz - 800 Hz	120 Hz - 6 kHz
	MC2F5360	53/60	106 Hz - 5.3 kHz	120 Hz - 6 kHz

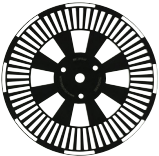
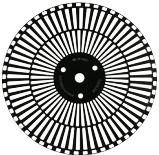
3.3. Front Panel Description



Figure 1: Front Panel

3.4. Rear Panel Description

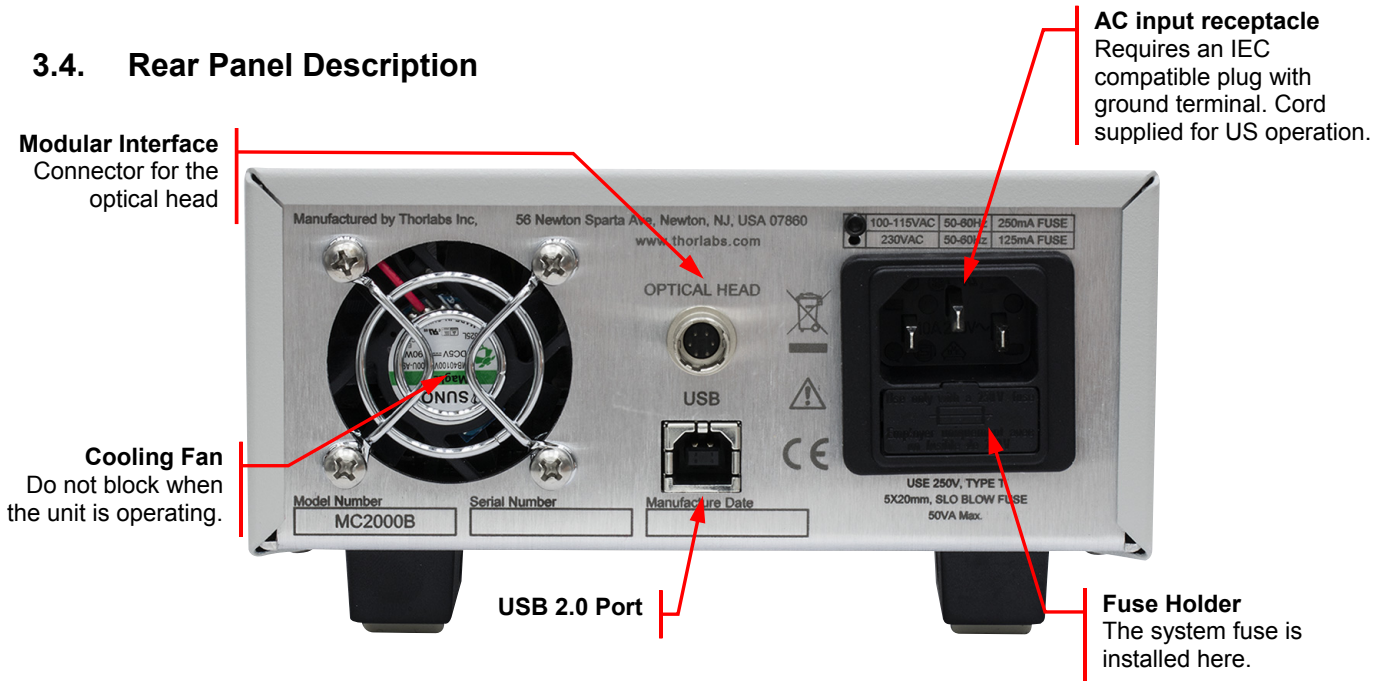

Figure 2: Rear Panel

Chapter 4 Setup

1. Carefully unpack the MC2000B controller, optical head, and accessories. See below for a complete list of parts. If any of the items appear damaged or missing, do not use the MC2000B. Contact your local Thorlabs office and arrange for a replacement. You can find the contact information on the last page of this manual.

Parts List:

- MC2000B Control Box
 - MC2000B Optical Chopping Head
 - MC1F10HP: Higher precision 10-slot chopping blade
 - 2 meter mini circular cable for optical head / control box interface
 - Power Supply Line Cord: 120 VAC with the MC2000B or 230 VAC with the MC2000B-EC
 - 125 mA Fuse for use at 230 VAC operation (250 mA fuse installed in unit)
 - 1/16" Allen Key for blade replacement
 - 0.05" Allen Key for hub alignment.
 - (3X) 4-40 x 1/8" Phillips Pan Head Screws with Internal Tooth Washers
2. Remove the three (3) mounting screws and lock washers from the chopper blade hub using the 1/16" hex key provided.
 3. Unpack the 10-slot blade, and connect it to the chopper blade hub using the three (3) screws and washers removed in the previous step. Tighten the screws securely with the hex wrench.
 4. Attach the modular cord into the circular connector labeled 'OPTICAL HEAD' on the back of the MC2000B controller, and plug the other end into the circular connector on the optical head.
 5. Mount the optical head on a sturdy surface in an area free of obstructions. Make sure the blade can spin freely.
 6. Attach the AC line cord to the MC2000B, and plug it into an AC outlet.

IMPORTANT

The MC2000B can be operated from 100/115 VAC or 230 VAC. A voltage selector switch is located inside of the MC2000B controller. If you are not sure what operating voltage your unit is set to, proceed immediately to Chapter 10 on page 21 for instructions on setting the operating voltage.

Chapter 5 Basic Operation

5.1. Internal Reference Operating Mode

The MC2000B is most often used in the internal reference mode, where the chopping speed is set internally.

1. Turn the MC2000B power on. The LCD display will show the Thorlabs logo and firmware revision number before changing to the top-level menu list. The display will then show the current menu, menu options, and operating status of the unit. By turning the front panel control knob, different menu items can be highlighted. Push the control knob to select the highlighted item.
2. Set the MC2000B parameters to the following for quick internal operation:
 - **Blade:** (MC1F10HP)
 - **Ref. In:** (INT-OUTER)
 - **Freq.:** Set to the desired frequency
 - **Phase:** Set to the desired phase
 - **Harm N:** Set the N harmonic to 1
 - **Harm D:** Set the D harmonic to 1
3. Highlight and select Run Mode. The unit will adjust the speed of the blade and lock onto the set speed within a few seconds.

5.2. External Reference Operating Mode

This mode allows the user to control the chopper blade with a logic-level external reference signal.

1. To enable external reference mode, attach a TTL or CMOS logic level reference signal, at the required frequency, to the 'EXT REF INPUT' BNC on the front panel. Turn the MC2000B power on.
2. Set the MC2000B parameters to the following for quick external operation:
 - **Blade:** (MC1F10HP)
 - **Ref. In:** (EXT-OUTER)
 - **Phase:** Set to the desired phase
 - **Harm N:** Set the N harmonic to 1
 - **Harm D:** Set the D harmonic to 1
3. Highlight and select Run Mode. The unit will adjust its speed and lock onto the external reference frequency within a few seconds.

Note, all menu parameters can be changed in standby mode, while only frequency and phase can be changed in run mode. Unless auto run has been selected, the unit always powers up in standby mode.

5.3. Reference-In Signal

The MC2000B supports a number of different reference-in signals. For reference input selection, highlight and select the reference-in signal from the following menu list.

- INTERNAL – The reference-in signal synthesized internally from a unit's crystal clock
- EXTERNAL – The reference-in signal obtained from the reference input connector. (EXT Input).
- INT-INNER – The reference-in signal synthesized internally from a unit's crystal clock and referenced to the inner slots of a 2/100-slot or 10/100-slot blade. (Note: This menu item is only displayed when these blades are selected.)
- INT-OUTER – The reference-in signal synthesized internally from a unit's crystal clock reference to the outer slots of a 2/100-slot or 10/100-slot blade. (Note: This menu item is only displayed when these blades are selected.)
- EXT-OUTER – The reference-in signal, obtained from the reference input connector (EXT Input), synchronized and locked to the outer slots of a 2/100-slot or 10/100-slot blade. (Note: This menu item is only displayed when these blades are selected.)
- EXT-INNER – The reference-in signal, obtained from the reference input connector (EXT Input), synchronized and locked to the inner slots of a 2/100-slot or 10/100-slot blade. (Note: This menu item is only displayed when these blades are selected.)

5.4. Reference-Out Signal

The MC2000B supports a number of different reference-out signals. For reference output selection, highlight and select the external reference-out signal from the following menu list.

- TARGET – The reference-out signal synthesized internally from a unit's crystal clock
- ACTUAL – The reference-out signal obtained from the feedback sensor reading the outer slots on a chopper wheel
- INNER – Reference-out signal obtained from the feedback sensors reading the inner slots of a 2/100-slot or 10/100-slot blade. (Note: This menu item is only displayed when these blades are selected.)
- OUTER – Reference-out signal obtained from the feedback sensor reading the outer slots of a 2/100-slot or 10/100-slot blade. (Note: This menu item is only displayed when these blades are selected.)
- SUM – The reference-out sum signal obtained from the two frequency blade (4/7, 5/7, 3/30, 8/60 and 53/60). (Note: This menu item is only displayed when these blades are selected.)
- DIFF – The reference-out difference signal obtained from the two frequency blade (4/7, 5/7, 3/30, 8/60 and 53/60). (Note: This menu item is only displayed when these blades are selected.)

5.5. On Cycle

When using an adjustable duty cycle blade (MC1F10A), the duty cycle of the MC2000B external output signal can match the duty cycle of the physically adjusted blade. The On Cycle scroll bar is found under the Reference menu.

- On Cycle – The duty cycle is presented in percent increments (1% to 50%), with 50 percent equal to a 50% slot opening. (Note: This menu is only present when an adjustable blade is selected.)



Figure 1 The MC1F10A Adjustable Duty Cycle Blade

For example, the blade shown above is physically set for 20%, and the On Cycle scroll bar is also set for 20% as seen in the figure below.

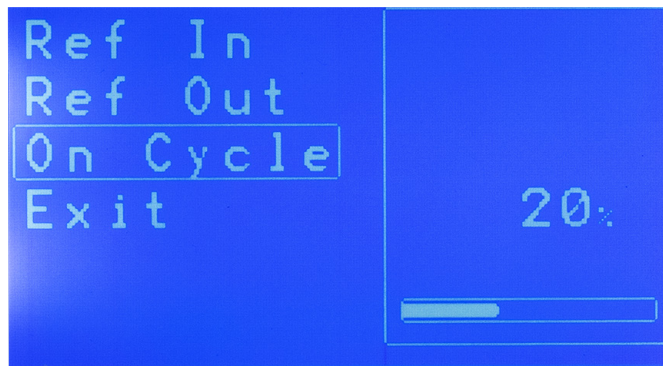

Figure 2 The MC2000B LCD displaying the On Cycle setting for a MC1F10A set to 20%

Chapter 6 Advanced Operating Instructions

6.1. Internal Frequency Synthesizer I

The MC2000B is most frequently used in this mode, where the chopper wheel frequency locks to an internal crystal stabilized frequency reference. The PLL motor speed control circuit maintains a precise lock to the frequency and phase of the internal reference frequency creating an ultra-stable chopping signal. The chopper wheel phase can be continuously adjusted.

6.1.1. Selecting the REFERENCE IN signal

When using the internal frequency synthesizer for single frequency blades, reference-in should be set to (INTERNAL). See section 5.3 on page 9 and section 6.5.1 on page 14 for more information on setting the reference-in with special blades.

6.1.2. Selecting the REFERENCE OUT signal

In the internal frequency mode for single frequency blades, the reference output signal can be set to the actual chopper wheel frequency (ACTUAL) or the internal frequency synthesizer (TARGET). In most cases, such as when selecting a reference for a lock-in amplifier, the chopper wheel frequency is used since it provides a direct measurement of the chopper phase and frequency. The chopper wheel reference derives from two photo-interrupters on the optical head that sense the motion of the chopper blade.

The internal frequency synthesizer has slightly less phase jitter than the chopper wheel reference, since it is not affected by external disturbances. Therefore, there may be cases where using the internal synthesizer as the reference output yields better performance (i.e. when synchronizing multiple choppers). See section 5.4 on page 9 and section 6.4.2 on page 13 for setting the reference-out for special blades.

6.2. External Reference Mode

A major benefit of using a PLL circuit to control the chopper wheel speed is that the chopper locks precisely to an external reference signal. This allows the MC2000B is used in advanced setups, for example, multiple MC2000B choppers can synchronize to a single reference signal, or master-slave combinations where one chopper is the master reference and a secondary chopper is slaved off the reference output of the first. The latter example provides a convenient way to measure long decay time fluorescence and other similar types of experiments.

The MC2000B also accepts a TTL or CMOS logic level input as an external reference. The advanced PLL design used in the MC2000B, even accepts reference signals that do not have a 50% duty cycle. A special feature of the external reference mode, locking to harmonics and sub-harmonics of the reference signal, is described in the following section.

6.2.1. Selecting the REFERENCE IN signal

In external reference mode for single frequency blades, reference-in should be set to (EXTERNAL). See section 5.3 on page 9 and section 6.5.1 on page 14 for more information on setting the reference-in with special blades.

6.2.2. Selecting the REFERENCE OUT signal

In the External frequency mode for single frequency blades, the reference output signal (ACTUAL) can be set to the actual chopper wheel frequency or the internal frequency synthesizer (TARGET). In most cases, only the actual chopper wheel frequency will ever be used in this mode.

See section 5.4 on page 9 and section 6.4.2 on page 13 for setting the reference-out for special blades.

6.3. Harmonic Reference Generation

Harmonic generation is a special feature available when operating in the external reference mode. The onboard microprocessor multiplies the external reference up to the 15th harmonic or divides the reference down to the 15th sub-harmonic. A fractional harmonic is obtained by combining both the frequency multiplication and division together. The new frequency is used as the chopper reference for chopping at a variety of frequency combinations, all derived from the external reference.

6.3.1. Selecting the REFERENCE IN Signal

Follow the setup procedures for internal reference operating mode in section 5.1 on page 8.

6.3.2. Setting the Sub-Harmonic

Highlight and select the reference harmonic N menu item and enter a scroll bar value between 1 and 15. Highlight and select the reference harmonic D menu item and enter a scroll bar value between 1 and 15.

6.3.3. Combining the Harmonic and Sub-Harmonic Modes

The sub-harmonic divider follows the harmonic multiplier. Therefore, the generated reference frequency will always be

$$f_{ext} = f_{ref} \frac{N}{D} \quad (\text{eq. 1})$$

There are no special steps to combine these two features since they are always active.

6.3.4. Selecting the REFERENCE OUT Signal

In the Harmonic frequency mode, a fractional harmonic reference output signal

$$(\text{Actual}) \frac{N}{D},$$

or the internal frequency synthesizer (TARGET) can be selected. Most cases in this mode, only the (ACTUAL) fractional harmonic reference output signal will ever be used.

6.4. Two-Frequency Chopping

Special (Inner/Outer) 4/7, 5/7, 3/30, 8/60, and 53/60 blades are available from Thorlabs. These unique prime number combinations allow the same chopper to discriminately chop two different light paths. This can be used in ratio metric measurements and pump-probe type experiments.

Note: The chopper wheel reference on two-frequency blades is derived from two photo-interrupters on the optical head that sense the motion of the chopper blade. Because the second photo-interrupter cannot physically measure the inner slots, a third set of slots on the rim of the blade was added. These slots exactly match the inner slots in orientation and frequency.

6.4.1. Selecting the REFERENCE IN Signal

Follow the setup procedures for internal reference operating mode in section 5.1 on page 8.

6.4.2. Selecting the REFERENCE OUT Signal

The MC2000B provides two additional reference outputs in this mode. The sum (SUM), and the difference (DIFF) reference frequencies track the combined signal paths when they are frequency mixed together. The example below illustrates this:

For example, an MC2000B 5/7 blade is set to run the outer blade set at 70 Hz. The inner blade, by virtue of the ratio of inner to outer slots will be running at 50 Hz. If a light path is common to both the inner and outer blades, the signal will see a sum frequency of 120 Hz and a difference frequency of 20 Hz.

6.4.3. Setting the Chopping Speed in the Two Frequency Mode

The chopping frequency for the two-frequency blade is set the same way as described above for the single frequency blades.

Note: The MC2000B synchronizes the outer portion of the two-frequency blade to the internal synthesizer or external reference. The inner portion is chopping at a rate given by, (Inner/Outer) * reference

$$f_{Inner} = f_{ref} \frac{Inner}{Outer}, \quad (eq. 2)$$

For example, if the internal reference of a 5/7 blade (or external reference) frequency is 100 Hz, the outer portion of the blade would be chopping at 100 Hz and the frequency of the inner portion could be found using equation 2.

$$f_{Inner} = 100 \text{ Hz} \left(\frac{5}{7} \right) = 71.42 \text{ Hz}.$$

6.5. Higher Precision Blades

The Higher precision blades provide very stable low frequency chopping. Up to a frequency of 200 Hz for the 2/100 slot blade and 1K Hz for the 10/100 slot blade. To accomplish the required high stability and minimize jitter, an outer blade frequency with a 50:1 ratio for 2/100 and a 10:1 ratio for the 10/100 slot blade is used. The optical chopper uses this outer frequency to lock the blade to either the internal or external frequency generator. In applications where phase is important, the MC2000B uses a dual photo-interrupter arrangement on the head to track the phase of the inner slot.

6.5.1. Selecting the REFERENCE IN Signal

If operated as a stand-alone unit, the internal reference signal will most likely be set to the inner (INT-OUTER) mode for the highest stability and least amount of jitter.

6.5.2. Selecting the REFERENCE OUT Signal

If operated as a stand-alone unit, the external reference out signal will most likely be set to the inner (INNER) mode. This will set the external reference out and display information to the inner slot frequency and phase of the blade.

6.5.3. Master Slave Configuration

If two units are synchronized in a master-slave configuration, the master unit will act as the frequency generator for the slave by connecting the reference out (REF OUT) of the master to reference in (REF IN) of the slave.

Master:

- Blade – (MC1F2)
- Ref. In – (INT-OUTER)
- Ref. Out – (OUTER)
- Freq. – Set to the desired frequency.
- Phase – Set to the desired phase.

Slave:

- Blade – (MC1F2)
- Ref. In – (EXT-OUTER)
- Ref. Out – (INNER)
- Phase – Set to the desired phase

6.6. Adjustable Duty Cycle Blade

A special adjustable duty cycle 10-slot blade is available. This blade, the MC1F10A, is partnered with our single frequency 10-slot blade (MC1F10) and provides 0 to 50% duty cycle capability. Engraved rulings on the outer edge of the blade are included for adjustability.

For proper mounting of the blade, align the engraved dots on the MC1F10 and MC1F10A so they overlap. Manually adjust the duty cycle and tighten the mounting screws

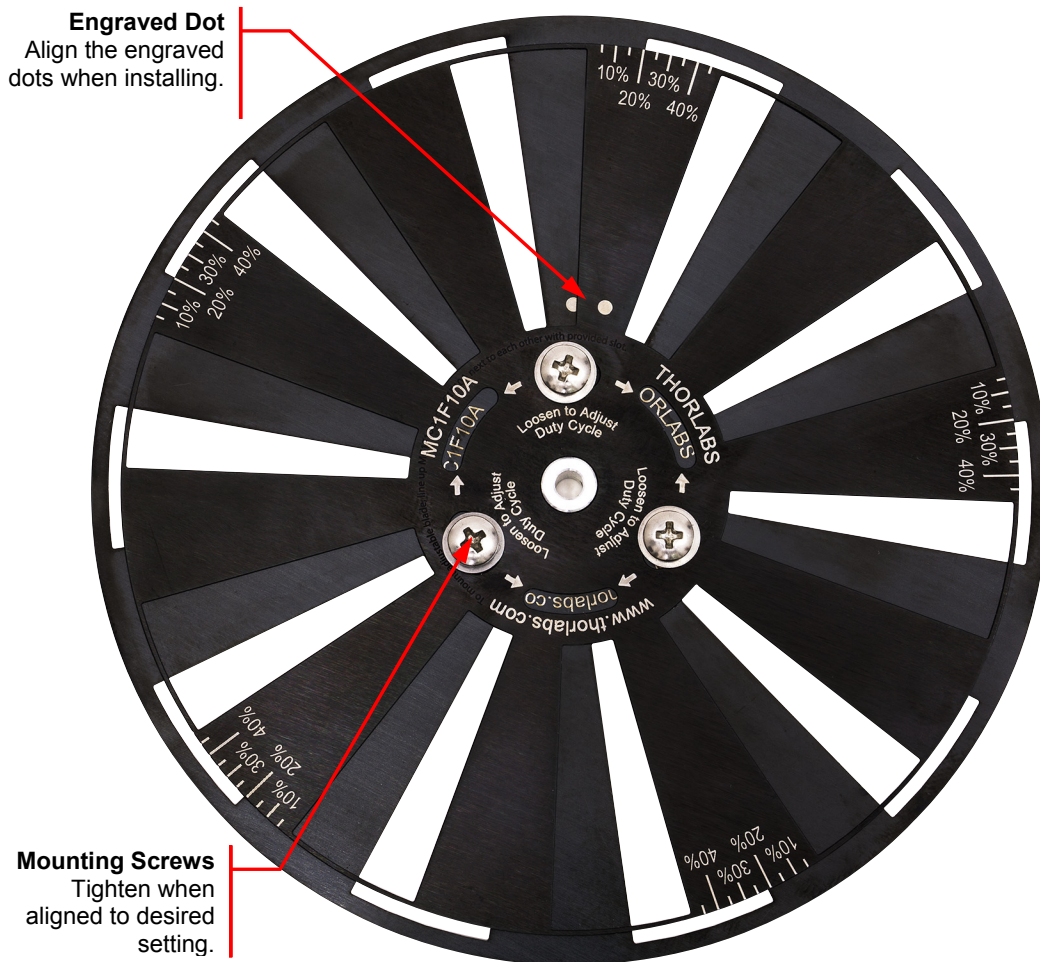

Figure 3: Adjustable Duty Cycle Blade

Note: Follow the operating mode setup procedures in Chapter 5 on page 8 for normal operation.

Chapter 7 Remote Communications

The MC2000B may also be controlled by a command line language through the USB port. This is offered to enable operation through a terminal interface or for those who may want to write their own program to control the system.

7.1. Installing the USB Drivers

Prior to running the command line interface, the USB drivers must be installed. The MC2000B must not be connected to the PC while installing the drivers. Insert the CD that was supplied with your unit into your PC. From the dialog box that is displayed, select the Install Drivers button. If the dialog box is not displayed, browse to the CD and run CD-Starter.exe. Follow the onscreen prompts to install the driver. After the driver is installed, attach the MC2000B to the PC and power it on. Your PC will then detect the new hardware and will prompt you when the installation is complete.

7.2. Command Line Interface

Once the USB drivers have been installed and the unit connected to the PC and powered on, configure the terminal emulator as follows:

- Baud Rate = 115.2K Bits Per Second
- Data Bits = 8
- Parity = None
- Stop Bits = 1
- Flow Control = None

If the connection is correct you will see the following after pressing the “Enter” key.

```
Command error CMD_NOT_DEFINED
```

Followed immediately by the prompt:

```
>
```

The basic structure of the interface is a keyword followed by either an equals sign “=” or a question mark “?”. The “=” or “?” will determine if the string is a command or a query. All strings (commands and queries) must be terminated by a carriage return (CR) or pressing the ENTER key on the computer.

The command structure is as follows:

```
Keyword=argument(CR)
```

Where “keyword” defines the function and “argument” is a numerical value followed by a carriage return (CR). See listing below.

The query structure is as follows:

```
Keyword?(CR)
```

The “keyword” defines the function and the question mark (?) indicates a query. The string is terminated with a carriage return (CR). See listing below. There are a few exceptions to this which are noted below.

The prompt symbol “>” will appear on power up and after a command is accepted by the system indicating it is ready to receive another command line.

Chapter 8 Commands

8.1. Commands and Queries

The following list shows all of the available commands and queries, and summarizes their functions:















Command	Syntax ¹	Description
Get Commands	?	List the available commands.
Get Identification	id?	Returns the model number and firmware version.
Set Frequency	freq= <i>n</i>	Set the desired internal reference frequency.
Get Frequency	freq?	Returns the internal reference frequency.
Get Ref-Out Frequency	refoutfreq?	Returns the reference output frequency.
Set Blade Type	blade= <i>n</i>	Set the blade type (<i>n</i> is number indicated in section 6.4).
Get Blade Type	blade?	Return the blade type (see section 6.4 for more details).
Set Harmonic Multiplier	nharmonic= <i>n</i>	Set Harmonic Multiplier applied to external reference frequency (1-15).
Get Harmonic Multiplier	nharmonic?	Returns the Harmonic Multiplier.
Set Harmonic Divider	dharmonic= <i>n</i>	Set the Harmonic Divider applied to external reference frequency (1-15).
Get Harmonic Divider	dharmonic?	Returns the Harmonic Divider.
Set Phase	phase= <i>n</i>	Set the Phase adjust (0-360°).
Get Phase	phase?	Returns the Phase adjust.
Set Enable	enable= <i>n</i>	Set Enable (0=disabled, 1=enabled).
Get Enable	enable?	Get Enable.
Set Reference	ref= <i>n</i>	Set the reference mode (* See blade dependent reference input)
Get Reference	ref?	Returns the reference mode.
Set Ref Output	output= <i>n</i>	Set the output reference mode (* See blade dependent reference output)
Get Ref Output	output?	Returns the output reference mode.
Set On Cycle	oncycle= <i>n</i>	Set On Cycle (1-50%)
Get On Cycle	oncycle?	Get On Cycle
Set Display Intensity	intensity= <i>n</i>	Set the Display Intensity (1-10).
Get Display Intensity	intensity?	Returns the Display Intensity.
Get Reference Frequency	input?	Returns the current supplied external reference frequency.
Restore	restore	Restore the factory default parameters.
Get Verbose	verbose?	Returns the verbose mode.
Set Verbose	verbose= <i>n</i>	When verbose mode is set to 1, status messages are output on the USB.

If the keyword, format, or argument is incorrect or out of range, the unit will return an error string. The function is determined by the value set with the mode command in the above table.

¹ All commands and queries are in lower case letters.

8.2. Blade Indices

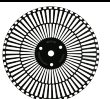
Blade type can be gotten or set through the command line interface using the commands “blade?” and “blade=*n*”, respectively. These commands do not denote blade type using product names. Rather, they index blade type using the numbers from 0 to 14. The following table provides the mapping:

Photo	Blade	Index	Photo	Blade	Index
	MC1F2	0		MC1F6P10	8
	MC1F10	1		MC1F10A	9
	MC1F15	2		MC2F330	10
	MC1F30	3		MC2F47	11
	MC1F60	4		MC2F57B	12
	MC1F100	5		MC2F860	13
	MC1F10HP	6		MC2F5360	14
	MC1F2P10	7			

8.3. Blade Dependent Reference Input

Reference mode can be gotten or set through the command line interface using the commands “ref?” and “ref=*n*”, respectively. The following table provides the mapping:

Blade	Internal	External	INT- OUTER	INT- INNER	EXT- OUTER	EXT- INNER
MC1F2			0	1	2	3
MC1F10	0	1				
MC1F15	0	1				
MC1F30	0	1				
MC1F60	0	1				
MC1F100	0	1				
MC1F10HP			0	1	2	3
MC1F2P10			0	1	2	3
MC1F6P10	0	1				
MC1F10A	0	1				
MC2F330	0	1				
MC2F47	0	1				
MC2F57B	0	1				
MC2F860	0	1				
MC2F5360	0	1				

8.4. Blade Dependent Reference Output

Reference mode can be gotten or set through the command line interface using the commands “output?” and “output=*n*”, respectively. The following table provides the mapping:

Blade	Target	Actual	Outer	Inner	Sum	Diff
MC1F2	0		1	2		
MC1F10	0	1				
MC1F15	0	1				
MC1F30	0	1				
MC1F60	0	1				
MC1F100	0	1				
MC1F10HP	0		1	2		
MC1F2P10	0		1	2		
MC1F6P10	0	1				
MC1F10A	0	1				
MC2F330	0		1	2	3	4
MC2F47	0		1	2	3	4
MC2F57B	0		1	2	3	4
MC2F860	0		1	2	3	4
MC2F5360	0		1	2	3	4

Chapter 9 Maintenance and Troubleshooting

9.1. Cleaning

The MC2000B should only be cleaned with a soft cloth and mild soap detergent or isopropyl alcohol. Do not use a solvent-based cleaner.

The optical chopper wheel may build up a layer of dust over time on the leading edges of the wheel. To clean the wheel, remove it from the optical head and wipe it clean with a cloth dampened in isopropyl alcohol. To help prevent the chopper wheel from rusting in high humidity environments, wipe the blade with a clean rag sprayed with a light lubricating rust inhibitor (e.g. WD40 or similar).

9.2. Diagnostic Messages

- During normal operation, a run time diagnostic message is displayed indicating whether the chopper is locked in both frequency and phase.

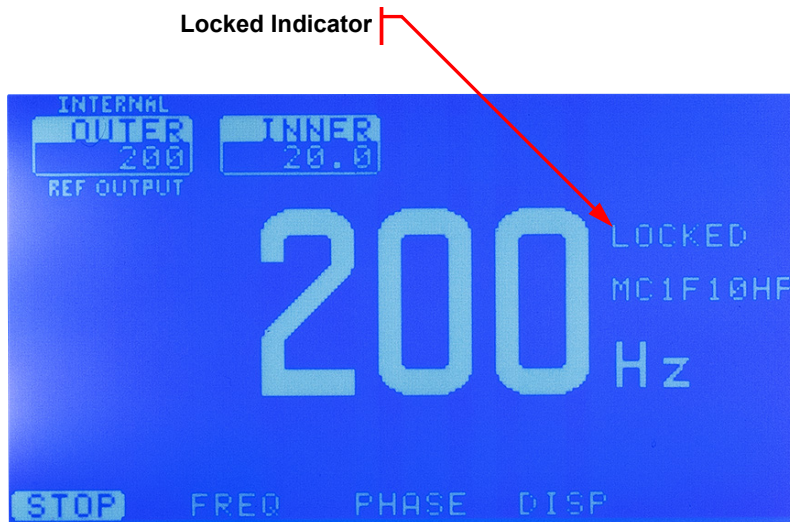

- If the unit is in external input mode, an out of range messages will be displayed if the external signal exceeds the blade limits.

Chapter 10 Fuse Replacement and Line Voltage Selection

Thorlabs ships the MC2000B unit configured to operate at 100/115 VAC and the MC2000B-EC configured to operate at 220/230 VAC. If the installed fuse needs to be replaced, follow the instructions below.



Warning Electrical Shock



The unit must be powered off, unplugged from the AC input power source, and disconnected from all external devices before removing the cover and replacing the fuse. Failure to do so may cause serious injury to the user since high voltages exist within the unit.

10.1. Materials Needed

- MC2000B Operating Manual
- 250 mA Type IEC60127-2/III, Type 'T' Slo-blo Fuse – The 250 mA fuse is installed in the MC2000B at the factory and must be used when operating the unit at 100/115 VAC.
- 125 mA Type IEC60127-2/III, Type 'T' Slo-blo Fuse – The 125 mA fuse is installed in the MC2000B-EC at the factory and must be used when operating the unit at 220/230 VAC.
- Phillips Head Screwdriver (#2 Preferred) – Motorized screwdrivers are not recommend.

10.2. Fuse Replacement and Line Voltage Selection

1. **Important!** – Make sure the power cord, optical head, and any external devices are disconnected before continuing. See warning above.
2. Remove the two screws securing the enclosure cover with a Phillips head screwdriver. The screws are located on the bottom side, rear corners of the unit. Place the screws in a safe location.
3. Carefully remove the cover by sliding it toward the rear of the unit.
4. To change the line voltage, locate the line select switch behind the power switch. Select the appropriate line voltage by adjusting the switch to either 110 or 220. Select 110 if operating at 100 to 120 VAC. Select 220 for operation from 220 to 240 VAC.
5. Replace the enclosure cover and secure with the enclosure screws.
6. Locate the fuse holder below the power input connector. Slide the fuse tray out using a flat head screwdriver. Remove the fuse and replace with the appropriate value as described below:
 - 100 – 120 VAC operation – Use the 250 mA fuse
 - 220 – 240 VAC operation – Use the 125 mA fuse

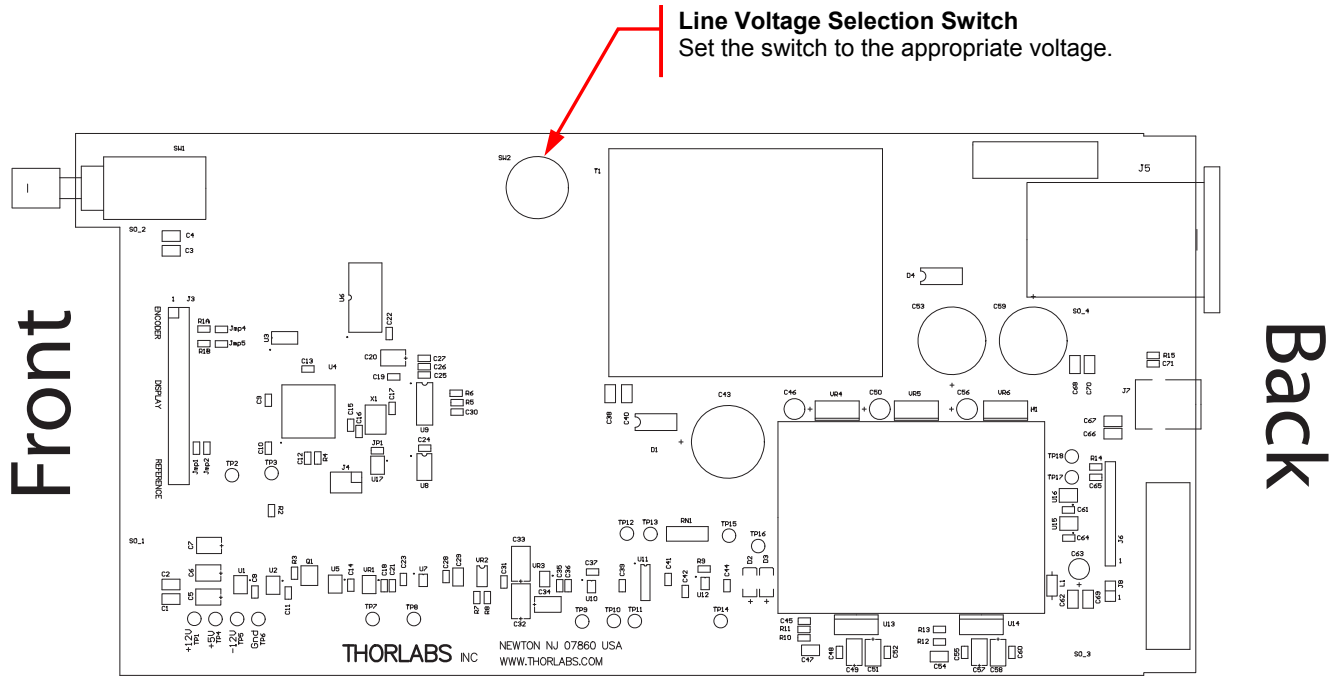
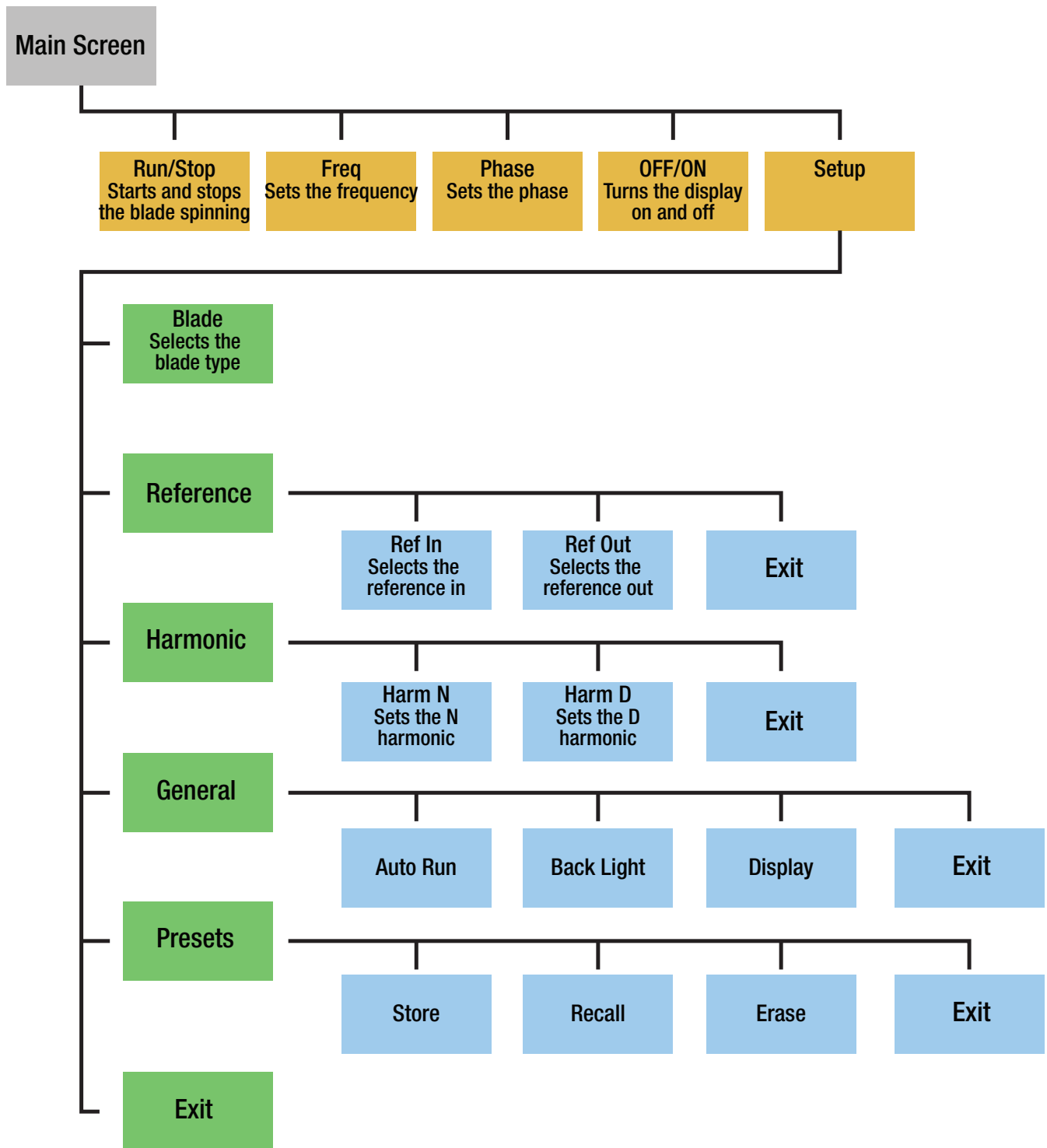

Figure 4: Circuit Board Layout with 110/220 VAC Switch

Chapter 11 Visual Menu Structure



Chapter 12 Specifications

12.1. Blade Specifications

Chopping Blade Slots ²	
MC1F2	2
MC1F10	10
MC1F15	15
MC1F30	30
MC1F60	60
MC1F100	100
MC1F10HP (Default Blade)	100 Outer, 10 Inner
MC1F2P10	10 – 10% Duty Cycle
MC1F6P10	6 – 10% Duty Cycle
MC1F10A	10 – Duty Cycle Adjustable
MC2F330	30 Outer, 3 Inner
MC2F47	7 Outer, 4 Inner
MC2F57B	7 Outer, 5 Inner
MC2F860	60 Outer, 8 Inner
MC2F5360	60 Outer, 53 Inner
Slot Angle	
MC1F2	180°
MC1F10	36°
MC1F15	24°
MC1F30	12°
MC1F60	6°
MC1F100	3.6°
MC1F10HP (Default Blade)	3.6° Outer, 36° Inner
MC1F2P10	180°
MC1F6P10	60°
MC1F10A	Adjustable
MC2F330	12° Outer, 120° Inner
MC2F47	51.4° Outer, 90° Inner
MC2F57B	51.4° Outer, 72° Inner
MC2F860	6° Outer, 45° Inner
MC2F5360	6° Outer, 6.79° Inner

² The MC1F10HP blade is supplied with the unit. All other blades specified may be purchased separately through Thorlabs.

Chopping Frequency	
MC1F2 (2 slot)	4 – 200 Hz
MC1F10 (10 slot)	20 – 1 kHz
MC1F15 (15 slot)	30 – 1.5 kHz
MC1F30 (30 slot)	60 – 3 kHz
MC1F60 (60 slot)	120 – 6 kHz
MC1F100 (100 slot)	200 – 10 kHz
MC1F10HP (2f slot, Default Blade)	Outer: 200 – 10 kHz Inner: 20 – 1 kHz
MC1F2P10 (2 slot – 10%)	4 – 200 Hz
MC1F6P10 (6 slot-10%)	12 – 600 Hz
MC1F10A (Adjustable Duty)	20 – 1 kHz
MC2F330 (2f slot)	Outer: 60 – 3 kHz Inner: 6 – 300 Hz
MC2F47 (2f slot)	Outer: 14 – 700 Hz Inner: 8 – 400 Hz
MC2F57B (2f slot)	Outer: 14 – 700 Hz Inner: 10 – 500 Hz
MC2F860 (2f slot)	Outer: 120 – 6 kHz Inner: 16– 800 Hz
MC2F5360 (2f slot)	Outer: 120 – 6 kHz Inner: 106 – 5.3 kHz
Phase Jitter (@ One Blade Rotation)	
MC1F2 (2 slot)	+/- 0.2° rms (0.1° rms Typ.)
MC1F10 (10 slot)	+/- 0.3° rms (0.2° rms Typ.)
MC1F15 (15 slot)	+/- 0.3° rms (0.15° rms Typ.)
MC1F30 (30 slot)	+/- 0.3° rms (0.15° rms Typ.)
MC1F60 (60 slot)	+/- 0.2° rms (0.1° rms Typ.)
MC1F100 (100 slot)	+/- 0.2° rms (0.1° rms Typ.)
MC1F10HP (2f slot, Default Blade)	+/- 0.2° rms (0.1° rms Typ.)
MC1F2P10 (2 slot - 10%)	+/- 0.2° rms (0.1° rms Typ.)
MC1F6P10 (6 slot - 10%)	+/- 0.5° rms (0.2° rms Typ.)
MC1F10A (Adjustable Duty)	+/- 0.3° rms (0.2° rms Typ.)
MC2F330 (2f slot)	+/- 0.3° rms (0.15° rms Typ.)
MC2F47 (2f slot)	+/- 0.5° rms (0.2° rms Typ.)
MC2F57B (2f slot)	+/- 0.5° rms (0.2° rms Typ.)
MC2F860 (2f slot)	+/- 0.2° rms (0.1° rms Typ.)
MC2F5360 (2f slot)	+/- 0.2° rms (0.1° rms Typ.)
Frequency Drift	<20 ppm/°C
Chopping Range	
Harmonic	2 to 15x
Sub-Harmonic	1/2 to 1/15x

12.2. Performance Specifications

Input/Output Specifications	
Ext. Input Compatibility	TTL/CMOS
Ext. Input Voltage Range ³	0 – 5 V
Input High	>2 V
Input Low	<0.8 V
Ext. Input Impedance	200Ω
Ref Out Compatibility	TTL/CMOS
Ref Out Voltage Range ³	0 – 5 V Typ.
Ref Out Impedance	200Ω
Min Load Impedance ⁴	500Ω
Ref Out Signals	Inner/Outer Slot Chopping Blade, Synthesizer, Sum and Diff Frequencies
Ref Out Selection	Selectable Menu or USB command 'O'
Communications	
Communications Port	USB
Protocol	USB (RS232 Emulated)
Baud Rate	115,200 (fixed)
Data Bits	8
Stop Bits	1
Parity	None
Handshaking	None
Optical Head Specifications	
Chopping Blade Diameter	Ø4.0" (Ø101.6 mm)
Chopping Blade Thickness	0.010" (0.254 mm)
Mounting Base	1/4"-20 (or M6) Clearance Slots Spaced 3.0" (Compatible with Thorlabs Breadboards)
Physical Features	
Dimensions (W x H x D)	6.05" x 2.88" x 11.54" (153.6 mm x 73.2 mm x 293.1 mm)
Input and Output Connectors	BNC
Menu Control	Twist / Push-Button Knob
Input Power Connection ⁵	IEC Connector
Weight	5 lbs (9.1 lbs Shipped Weight)
Operating Temperature	10 – 40 °C
Display Type	240 x 124 Pixel LCD Graphics Display
Frequency Resolution	1 Hz (10, 15, 30, 60 and 100 – "Single Frequency" Blades) 1 Hz (4/7, 5/7, 3/30, 8/60 and 53/60 – "Harmonic" Blades) 0.1 Hz (10/100 slot – "Higher Precision" Blades) 0.01 Hz (2 slot – 10% and 50% Duty Cycle – "Higher Precision" Blades)

³ The reference output and external input is short circuit protected by limiting the current to 25 mA. Over and under voltage protection is available, but continued use will degrade or damage the unit.

⁴ The Min Load Impedance represents the smallest allowable terminating resistance. Applying lower impedances will cause the short circuit protection to limit the output voltage. Continued use in this mode will cause circuit degradation and eventual circuit failure.

⁵ The MC2000B is shipped with a 120 VAC US style power cord while the MC2000B-EC is shipped with a 230 VAC power cord.

Power Supply	
Supply Type	Linear
Voltage Selection	Switch Selectable between 115 / 230 VAC
Input Voltage	100/115 VAC \pm 10%, 230 VAC \pm 10%
Line Frequency	50 – 60 Hz
Input Power	20 VA Max
Fuse Ratings	250 mA @ 115 VAC 125 mA @ 230 VAC
Fuse Type	IEC60127-2/III (250 V, Slo-blo Type 'T')
Fuse Size	5 x 20 mm

Chapter 13 Mechanical Drawing

13.1. Console Dimension Drawing

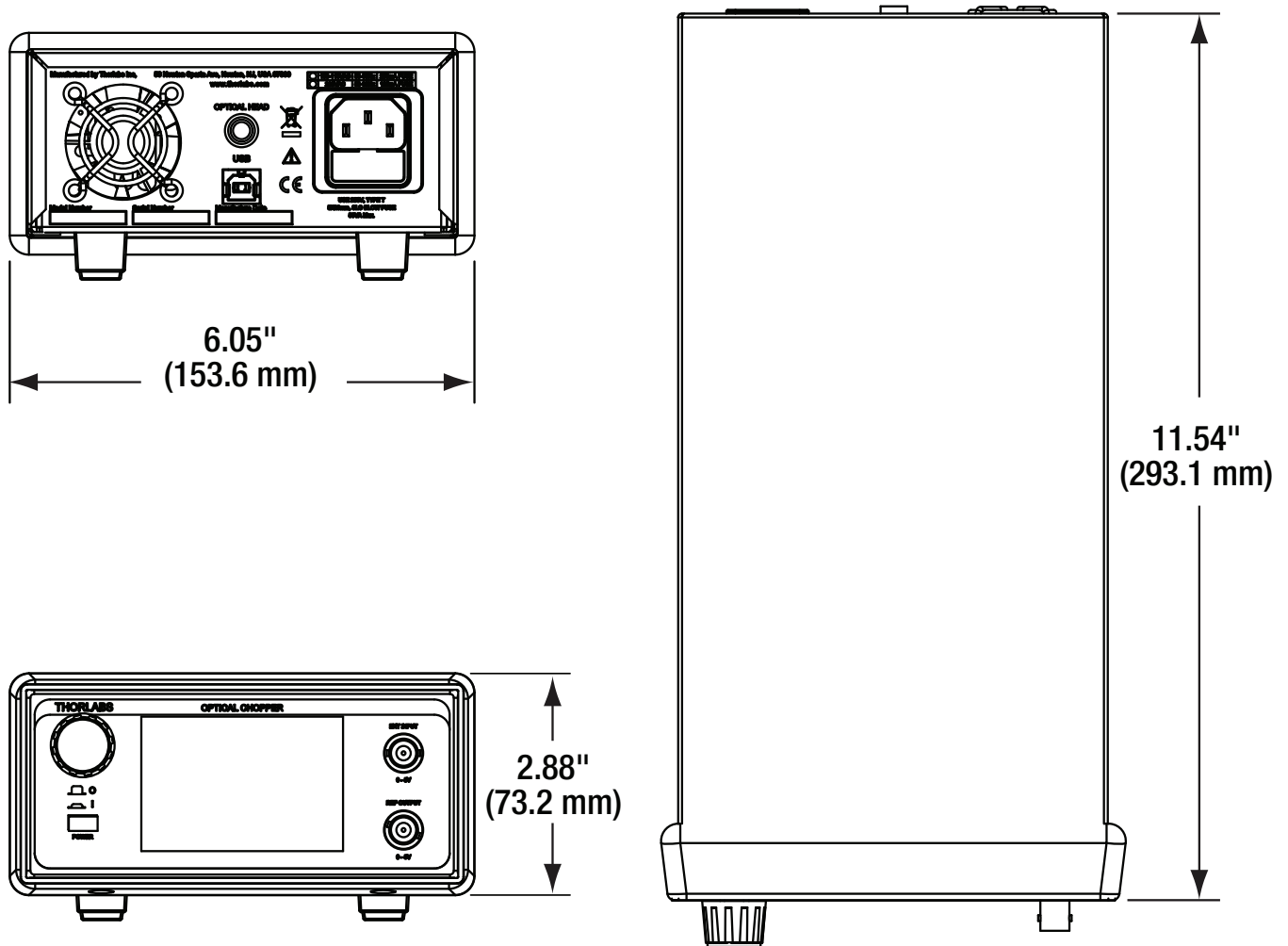

Figure 5: Console Dimension Drawing

13.2. Chopper Head Dimension Drawing

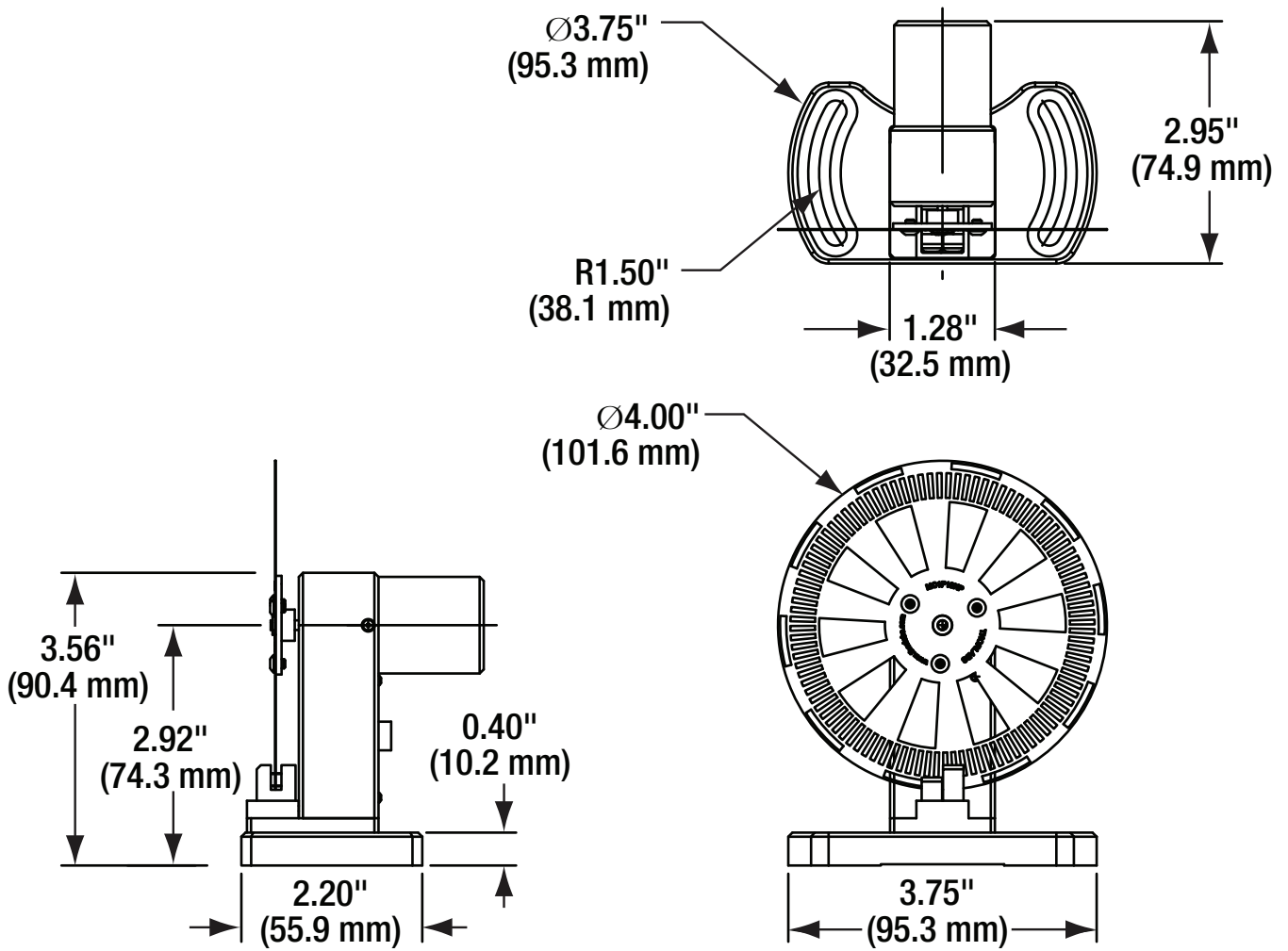

Figure 6: Chopper Head Dimension Drawing

Chapter 14 Regulatory

As required by the WEEE (Waste Electrical and Electronic Equipment Directive) of the European Community and the corresponding national laws, Thorlabs offers all end users in the EC the possibility to return “end of life” units without incurring disposal charges.

- This offer is valid for Thorlabs electrical and electronic equipment:
- Sold after August 13, 2005
- Marked correspondingly with the crossed out “wheelie bin” logo (see right)
- Sold to a company or institute within the EC
- Currently owned by a company or institute within the EC
- Still complete, not disassembled and not contaminated



Wheelie Bin Logo

As the WEEE directive applies to self-contained operational electrical and electronic products, this end of life take back service does not refer to other Thorlabs products, such as:

- Pure OEM products, that means assemblies to be built into a unit by the user (e. g. OEM laser driver cards)
- Components
- Mechanics and optics
- Left over parts of units disassembled by the user (PCB's, housings etc.).

If you wish to return a Thorlabs unit for waste recovery, please contact Thorlabs or your nearest dealer for further information.

Waste Treatment is Your Own Responsibility

If you do not return an “end of life” unit to Thorlabs, you must hand it to a company specialized in waste recovery. Do not dispose of the unit in a litter bin or at a public waste disposal site.

Ecological Background

It is well known that WEEE pollutes the environment by releasing toxic products during decomposition. The aim of the European RoHS directive is to reduce the content of toxic substances in electronic products in the future.

The intent of the WEEE directive is to enforce the recycling of WEEE. A controlled recycling of end of life products will thereby avoid negative impacts on the environment.

Chapter 15 Declaration of Conformity



EU Declaration of Conformity
in accordance with EN ISO 17050-1:2010

We: Thorlabs Inc.
Of: 56 Sparta Avenue, Newton, New Jersey, 07860, USA
in accordance with the following Directive(s):

- Machinery Directive (MD)
- Electromagnetic Compatibility (EMC) Directive
- Restriction of Use of Certain Hazardous Substances (RoHS)

hereby declare that:
Model: **MC2000B-EC**

Equipment: **Optical Chopper**

is in conformity with the applicable requirements of the following documents:

Title47 Part15(B) FCC Telecommunication	2016
---	------

and which, issued under the sole responsibility of Thorlabs, is in conformity with Directive 2011/65/EU of the European Parliament and of the Council of 8th June 2011 on the restriction of the use of certain hazardous substances in electrical and electronic equipment, for the reason stated below:

does not contain substances in excess of the maximum concentration values tolerated by weight in homogenous materials as listed in Annex II of the Directive

I hereby declare that the equipment named has been designed to comply with the relevant sections of the above referenced specifications, and complies with all applicable Essential Requirements of the Directives.

Signed:  On: 27 May 2016

Name: Ann Strachan
Position: Compliance Manager

EDC - MC2000B-EC -2016-05-27 

Chapter 1* Thorlabs Worldwide Contacts

USA, Canada, and South America

Thorlabs, Inc.
56 Sparta Avenue
Newton, NJ 07860
USA
Tel: 973-300-3000
Fax: 973-300-3600
www.thorlabs.com
www.thorlabs.us (West Coast)
Email: sales@thorlabs.com
Support: techsupport@thorlabs.com

Europe

Thorlabs GmbH
Hans-Böckler-Str. 6
85221 Dachau / Munich
Germany
Tel: +49-(0) 8131-5956-0
Fax: +49-(0) 8131-5956-99
www.thorlabs.de
Email: europe@thorlabs.com

France

Thorlabs SAS
109, rue des Côtes
78600 Maisons-Laffitte
France
Tel: +33 (0) 970 444 844
Fax: +33 (0) 825 744 800
www.thorlabs.com
Email: sales.fr@thorlabs.com

Japan

Thorlabs Japan, Inc.
3-6-3 Kitamachi,
Nerima-ku, Tokyo 179-0081
Japan
Tel: +81-3-6915-7701
Fax: +81-3-6915-7716
www.thorlabs.co.jp
Email: sales@thorlabs.jp

UK and Ireland

Thorlabs Ltd.
1 Saint Thomas Place
Ely CB7 4EX
Great Britain
Tel: +44 (0) 1353-654440
Fax: +44 (0) 1353-654444
www.thorlabs.com
Email: sales.uk@thorlabs.com
Support: techsupport.uk@thorlabs.com

Scandinavia

Thorlabs Sweden AB
Bergfotsgatan 7
431 35 Mölndal
Sweden
Tel: +46-31-733-30-00
Fax: +46-31-703-40-45
www.thorlabs.com
Email: scandinavia@thorlabs.com

Brazil

Thorlabs Vendas de Fotônicos Ltda.
Rua Riachuelo, 171
São Carlos, SP 13560-110
Brazil
Tel: +55-16-3413 7062
Fax: +55-16-3413 7064
www.thorlabs.com
Email: brasil@thorlabs.com

China

Thorlabs China
Room A101, No. 100, Lane 2891,
South Qilianshan Road
Putuo District
Shanghai 200331
China
Tel: +86 (0) 21-60561122
Fax: +86 (0) 21-32513480
www.thorlabschina.cn
Email: chinasales@thorlabs.com



THORLABS
www.thorlabs.com
