

ENSP E 99/02

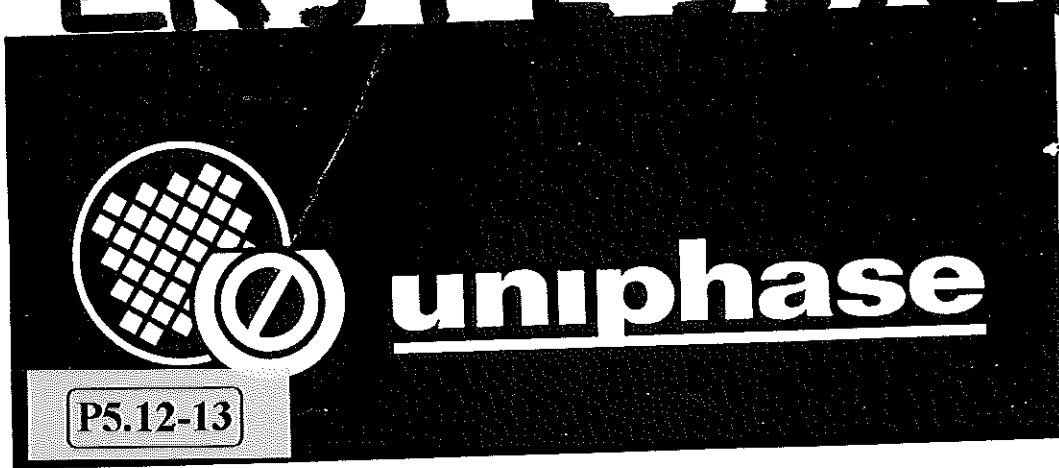

Helium-Neon Lasers

Installation

and

Operation

Manual

Notice

The information contained in this document is subject to change without notice.

Uniphase shall not be liable for errors contained herein or for incidental or consequential damages in connection with the furnishing, performance, or use of this material.

This document contains proprietary information, which is protected by copyright. All rights are reserved. No part of this document may be copied or reprinted without the prior written consent of Uniphase.

Copyright © 1997 by Uniphase Corporation.

Printed in the USA (11/97)

Contents

Model Selections	1
Laser Safety Precautions	2
Safety Recommendations	2
Compliance Features	2
Protective Housing	3
Remote Control Connector (where required).....	3
Key Control (where required)	3
Laser Radiation Emission Indicator	3
Beam Attenuator	3
Safety Labels	3
Laser Safety Informational Sources	4
Labels	5
Warning Logotype and Aperture Labels.....	5
Certification and Identification Labels.....	6
Novette Labels	6
Label Placement	7
Specifications	8
Model 100 and 1100 Series.....	8
Model 1600 Series.....	10
1500 Series Novette™	12
Environmental Specifications	13
Common Laser Specifications	13
Drawings	14
1100 & 1600 Series Laser Heads	14
1500 Series Laser System	15
1500 Series Energizer	15
Operation and Maintenance	16
Initial Procedure	16
Troubleshooting	16
Warranty.....	17
Shipping Instructions	17

Caution

Use of controls or adjustments, or performance of procedures other than those specified herein may result in hazardous radiation exposure.



Model Selections

System	Packaged Head	Output (mW)	Power Supply
			1205-X***
1308, 1308P**	1108, 1108P	0.5	1205-X
1307, 1307P	1107, 1107P	0.8	1201-X
1301, 1301P	1101, 1101P	1.5	1201-X
1303, 1303P	1103, 1103P	2.0	1206-X
1322, 1322P	1122, 1122P	2.0	1202-X
1325, 1325P	1125, 1125P	5.0	1216-X
1335, 1335P	1135, 1135P	10.0	1202-X
1337, 1337P	1137, 1137P	7.0	1202-X
1352, 1352P	1652, 1652P	0.25	1207-X
1353	1653	0.50	1207-X
1354	1654	0.75	1207-X
1354M	1654M	1.0	1208-X
1373P	1673P	0.50	1208-X
1374P	1674P	0.75	1208-X
1375	1675	1.0	1208-X
1376	1676	1.5	1208-X
1376M	1676M	1.6	1208-X
1377	1677	1.0	1207-X
1378M	1678M	1.5	1207-X
1379	1679	3.0	1207-X
1344, 1344P	1144, 1144P	17	1218-X
1345, 1345P	1145, 1145P	25/22	1218-X

* Minimum rated output power.

** "P" designates linearly polarized output.

*** "X" = Specify -1 for 100/120 Vac or -2 for 220 Vac.

All laser systems are provided with Alden-type connectors or equivalent unless otherwise specified.

A laser system consists of a packaged head and power supply.

System	Description	AC Converter
1508-1	0.5 mW Randomly Polarized, 633nm	120 Vac
1508P-1	0.5 mW Linearly Polarized, 633nm	120 Vac
1508-2	0.5 mW Randomly Polarized, 633nm	220 Vac
1508P-2	0.5 mW Linearly Polarized, 633nm	220 Vac
1508P-3	0.5 mW Linearly Polarized, 633nm	100 Vac
1508-3	0.5 mW Randomly Polarized, 633nm	100 Vac
1507-1	0.8 mW Randomly Polarized, 633nm	120 Vac
1507P-1	0.8 mW Linearly Polarized, 633nm	120 Vac
1507-2	0.8 mW Randomly Polarized, 633nm	220 Vac
1507-3	0.8 mW Randomly Polarized, 633nm	100 Vac
1507P-2	0.8 mW Linearly Polarized, 633nm	220 Vac
1507P-3	0.8 mW Linearly Polarized, 633nm	100 Vac

* Minimum rated output power.

Laser Safety Precautions

It is recommended that all persons who will use, or be in the vicinity of lasers, be aware of the potential hazards.

The laser plasma tube and ballast resistance are sealed in the laser head. Access to these parts by the laser user is not intended. Please contact a Uniphase representative for any maintenance or service of the head.

Warning

The laser head starting and operating voltages are lethal and are specified herein. Should access to the Model 1200 Series power supply be necessary, make sure that the power supply is turned off and unplugged. If it is necessary to operate the laser head while the interior of the power supply is exposed, extreme caution is advised to avoid exposure to these voltages.

Safety Recommendations

1. Never look directly into the laser beam
2. Controlled-access areas are suggested for laser operation. Limit access to this area to persons required to be there and who have been instructed in the safe operation of lasers.
3. Post warning signs in prominent locations near the laser area.
4. Provide enclosed paths for laser beams when possible.
5. Set up experiments so the laser beam is NOT at eye level.
6. Set up a target for the beam. V-shaped targets sprayed with a flat black paint into which the beam "dumps" works well. Shielding reflections which go beyond the experiment is also suggested.

The model 100, 1100, 1500 and 1600 Series products comply with Title 21, U.S. Government FDA/CDRH Performance Standards, Chapter 1, Section 1040, as applicable. These products fall into Class II, IIIa or IIIb. These products are also in conformance with the European Laser Safety Standard IEC 825-1:1993.

Compliance Features

Protective Housing

The housing of the laser head is designed to prevent collateral radiation in excess of admissible limits, as well as laser radiation in excess of the accessible emission limits of Class I lasers (See beam attenuation, below).

Remote Control Connector (where required)

A remote control connector is provided. When this two-pronged plug is removed, the power supply will not operate; the plug has its terminals shorted.

It is desirable in some working areas to employ a remote switch. Remove the short and connect these terminals to the remote switch. Be aware that the laboratory line voltage is across these terminals when unshorted.

Key Control (where required)

The power supply is activated when the key is turned to the "ON" position. A three second time delay occurs before the laser is activated. Note that the key cannot be removed when turned to the "ON" position.

Laser Radiation Emission Indicator

The Emission indicator lights immediately when the key control is turned the the "ON" position.

Beam Attenuator

The attenuator, located on the output end of the laser head, is designed to prohibit laser radiation in excess of the accessible emission limit of Class I lasers. Keep the attenuator in its closed position when not operating the laser.

Safety Labels

The required labels for Class II, IIIa and IIIb CDRH standards shown on page 6.

Laser Safety Informational Sources

Sources for additional information and assistance on laser safety are:

Regulations & Requirements

Director (HFZ-84)
Center for Devices and Radiological Health
Food and Drug Administration
5600 Fisher Lane
Rockville, MD 20857

Safety Guides

Laser Institute of America
12424 Research Parkway, Suite 125
Orlando, FL 32826-3274
Tel (800) 380-1553
Fax (407) 380-5588

Safety Guides

American National Standards Institute, Inc.
1430 Broadway
New York, NY 10018

Labels

Warning Logotype and Aperture Labels



Certification and Identification Labels

	
1096 MELLON AVE MANTECA, CA 95336	
LASER POWER SUPPLY	
MODEL	_____
SERIAL NO.	_____
POWER:	_____
	VOLTS AMPS
MADE IN U.S.A.	

	
1096 MELLON AVENUE MANTECA, CA 95336	
MODEL	_____
SERIAL NO.	_____
MANUFACTURED	_____
PATENT NOS. 4,302,191; 4,631,737; 4,750,182; and 5,004,843	
THIS LASER PRODUCT COMPLIES WITH 21 CFR 1040 AS APPLICABLE	
MADE IN U.S.A.	

	
1096 Mellon Ave. Manteca, CA 95336	
MODEL	SER

Novette Labels

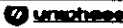
	
1096 MELLON AVE. MANTECA CA 95337	
NOVETTE	
MODEL	_____
INPUT VOLTS 12VDC	AMPS 7
SERIAL NO.	_____
MANUFACTURED	_____
ON OFF	

PAT. NOS. 4,357,885 & 4,611,717 MADE IN U.S.A.	

	
LASER RADIATION IS EMITTED FROM THIS APERTURE	
AVOID EXPOSURE	
THIS LASER PRODUCT COMPLIES WITH 21 CFR 1040 AS APPLICABLE	

Label Placement

Cylindrical Head Package

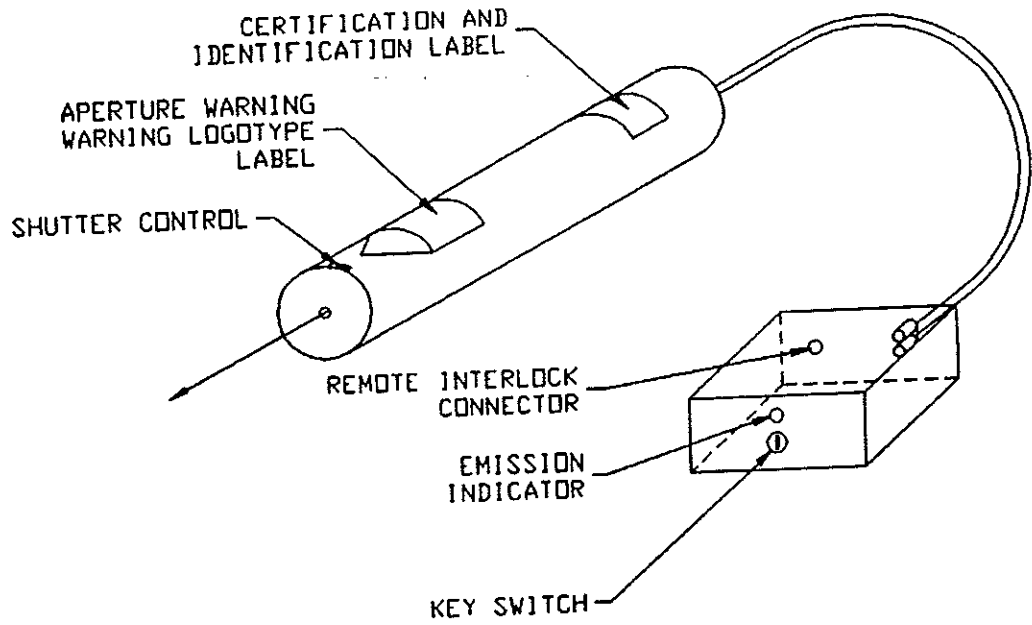

Novette Package

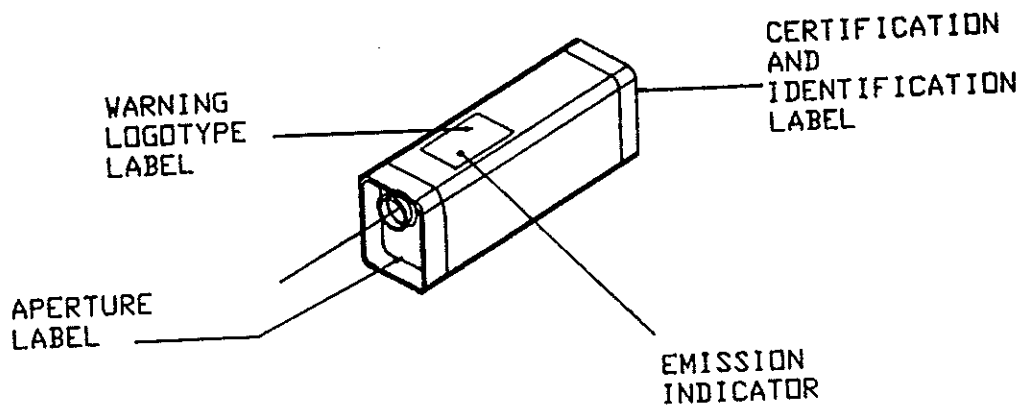

Specifications

Model 100 and 1100 Series

	1108	1107
	1108P	1107P
Minimum output power (mW, TEM ₀₀ , 633nm)	0.5	0.8
Wavelength (nm)	633	633
Beam diameter (mm, TEM ₀₀ , 1/e2 points ± 3%)	0.48	0.48
Beam divergence (mrad, TEM ₀₀ , ± 3%)	1.7	1.7
Minimum polarization ratio (P versions)	500:1	500:1
Longitudinal mode spacing (MHz)	1090	1090
Amplitude fluctuations:		
Maximum noise (rms) (30 Hz-10 Mhz) *, **	0.1%	0.1%
Maximum drift with respect to mean power measured over 8 hours	±2.5%	±2.5%
Maximum mode sweeping contribution	20%	10%
Maximum warm-up time (minutes to 95% power)	10	10
Beam pointing stability from cold start (25° C) (mrad)	N/A	N/A
After 15 minute warm-up (mrad)	N/A	N/A
Operating voltage (Vdc ± 100)	1350	1350
Operating current (mA ± 0.1 mA)	4.0	4.0
Maximum starting voltage (KVdc)	7	7
Expected operating lifetime (hours)	>20,000	>20,000
Weight (Laser tubes and 1100 Series heads)	2 lb.	2 lb.
Weight (Head and 1200 Series power supply)	7 lb.	7 lb.
CDRH Class (1300 Series)	II	IIIa
IEC 825-1 Class (1300 Series)	2	3B

* TEM₀₀ version only

** When used in conjunction with Uniphase Model 1200 Series power supply.

All specifications are subject to change without notice.

Specifications

Model 1600 Series

	1652	1653	1674P
	1652P		
Minimum output power (mW, TEM ₀₀ , 633nm)	0.25	0.50	0.50
Wavelength (nm)	543.5	543.5	543.5
Mode purity (TEM ₀₀)	>95%	>95%	>95%
Beam diameter (mm, TEM ₀₀ , 1/e ² points ± 3%)	0.70	0.70	0.80
Beam divergence (mrad, TEM ₀₀ , ± 3%)	0.98	0.98	0.86
Minimum polarization ratio (P versions)	500:1	N/A	500:1
Longitudinal mode spacing (MHz)	441	441	325
Amplitude fluctuations:			
Maximum noise (rms) (30 Hz-10 Mhz) *	0.25%	0.25%	0.25%
Maximum drift with respect to mean power measured over 8 hours	±2.5%	±2.5%	±2.5%
Maximum mode sweeping contribution	3%	3%	3%
Maximum warm-up time (minutes to 95% power)	15	15	30
Beam pointing stability from cold start (25° C) (mrad)			
	<0.10	<0.10	<0.20
After 15 minute warm-up (mrad)	<0.02	<0.02	<0.03
Operating voltage (Vdc ± 100)			
	2250	2250	2700
Operating current (mA ± 0.1 mA)			
	5.5	5.5	5.0
Maximum starting voltage (KVdc)			
	10	10	10
Expected operating lifetime (hours)			
	>20,000	>20,000	>20,000
Weight (1600 Series heads)			
	3 lb.	3 lb.	3 lb.
Weight (Head and 1200 Series power supply)			
	8 lb.	8 lb.	9 lb.
CDRH Class (1300 Series)			
	IIIa	IIIa	IIIa
IEC 825-1 Class (1300 Series)			
	3B	3B	3B

* When used in conjunction with Uniphase Model 1200 Series power supply.

** Multimode lasers

All specifications are subject to change without notice.

Model 1600 Series (continued)

1652	1654M	167AP	1675	1676	1676M	1677	1678M	1679
0.75	1.00	0.75	1.00	1.50	1.60	1.00	1.50	3.00
543.5	543.5	543.5	543.5	543.5	543.5	594	594	612
>95%	multimode	>95%	>95%	>95%	multimode	>95%	multimode	>95%
0.70	2.50	0.80	0.80	0.80	2.70	0.73	2.50	0.74
0.98	0.98	0.86	0.86	0.86	0.86	1.00	1.00	1.10
N/A	N/A	500:1	N/A	N/A	N/A	N/A	N/A	random
441	N/A	325	325	325	N/A	N/A	N/A	N/A
0.25%	1.0%	0.25%	0.25%	0.25%	1.0%	0.25%	1.0%	0.25%
±2.5%	±2.5%	±2.5%	±2.5%	±2.5%	±2.5%	±2.5%	±2.5%	±2.5%
3%	3%	3%	3%	3%	3%	±10%	±10%	±5%
15	15	30	30	30	30	15	15	15
<0.10	<0.10	<0.20	<0.20	<0.20	<0.20	<0.10	<0.10	<0.10
<0.02	<0.02	<0.03	<0.03	<0.03	<0.03	<0.02	<0.02	<0.02
2250	2250	2700	2700	2700	2700	2250	2250	2250
5.5	5.5	5.0	5.0	5.0	5.0	5.5	5.5	5.5
10	10	10	10	10	10	10	10	10
>20,000	>20,000	>20,000	>20,000	>20,000	>20,000	>20,000	>20,000	>20,000
3 lb.	3 lb.	3 lb.	3 lb.	3 lb.	3 lb.	3 lb.	3 lb.	3 lb.
8 lb.	8 lb.	9 lb.	9 lb.	9 lb.	9 lb.	8 lb.	8 lb.	8 lb.
IIIa	IIIa	IIIa	IIIa	IIIa	IIIa	IIIa	IIIa	IIIa
3B	3B	3B	3B	3B	3B	3B	3B	3B

Specifications

1500 Series Novette™

	1508	1507
	1508P	1507P
Minimum output power (mW, TEM ₀₀ , 633nm)	0.50	0.80
Wavelength (nm)	633	633
Beam diameter (mm, TEM ₀₀ , 1/e2 points ± 3%)	0.48	0.48
Beam divergence (mrad, TEM ₀₀ , ± 3%)	1.7	1.7
Minimum polarization ratio (P versions)	500:1	N/A
Longitudinal mode spacing (MHz)	1090	1090
Amplitude fluctuations:		
Maximum noise (rms) (30 Hz-10 Mhz) *, **	1.0%	1.0%
Maximum drift with respect to mean power measured over 8 hours	±2.5%	±2.5%
Maximum mode sweeping contribution	20%	10%
Maximum warm-up time (minutes to 95% power)	10	10
Beam pointing stability from cold start (25° C) (mrad)		
After 15 minute warm-up (mrad)	N/A	N/A
Operating current (mA ac at 120 Vac)		
	150	150
Operating current (mA ac at 200 Vac)		
	82	82
Expected operating lifetime (hours)		
	>12,000	>12,000
Weight		
	4 lb.	4 lb.
CDRH Class (1300 Series)		
	II	IIIa
IEC 825-1 Class (1300 Series)		
	2	3B

Specifications

Environmental Specifications

	Operating	Non-Operating
Temperature	-40° to 70°C	-40° to 150°C
Temperature (1507/1508)	0° to 35°C	-40° to 70°C
Altitude	0 to 10,000 feet	0 to 70,000 feet
Relative humidity (without condensation)	0 to 100%	0 to 100%
Shock	25g for 11 msec	25g for 11 msec
	100g for 1 msec	100g for 1 msec

Common Laser Specifications

	Value
Storage Lifetime	Indefinite (hard-sealed)
Static Alignment	
1100 and 1300 Series (excluding 1108, 1107, 1101 and 1103)	Centered to outer cylinder within 0.01 in. Parallel to outer cylinder within 1 mrad
098 Series and 1000 Series Tubes	Centered to mirror hub within 0.01 in. Parallel to mirror hub within 6 mrad

Drawings *(Dimensions in inches)*

1100 & 1600 Series Laser Heads

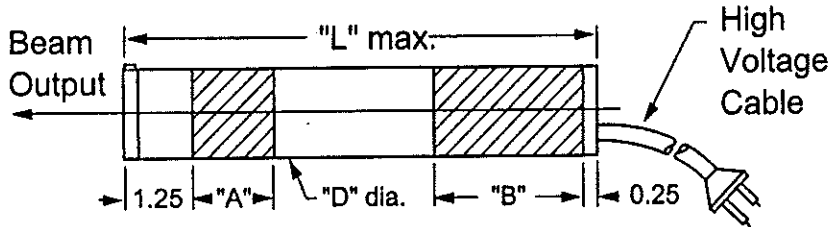

Accessory Housing Holes:
M-3 on 1.38" (34.9 mm) bolt circle.
(1.740" diameter head only)

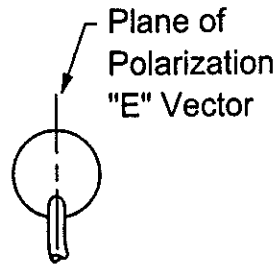
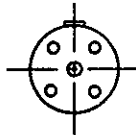

Models	"L"	"D"	"A"	"B"
1107, 1107P, 1108, 1108P	7.00	1.245 ± .005	1.0	1.0
1101, 1101P, 1103, 1103P	9.50	1.245 ± .005	1.5	3.0
1122, 1122P	10.71	1.740 ± .005	1.5	3.0
1125, 1125P, 1137, 1137P 1652, 1652P, 1653, 1654, 1654M, 1677, 1678M, 1679	15.79	1.740 ± .005	4.5	4.5
1135, 1135P, 1673P, 1674P, 1675, 1676, 1676M	19.13	1.740 ± .005	2.5	1.25
1144, 1144P, 1145, 1145P	25.00	1.740 ± .005	4.0	4.0

1500 Series Laser System

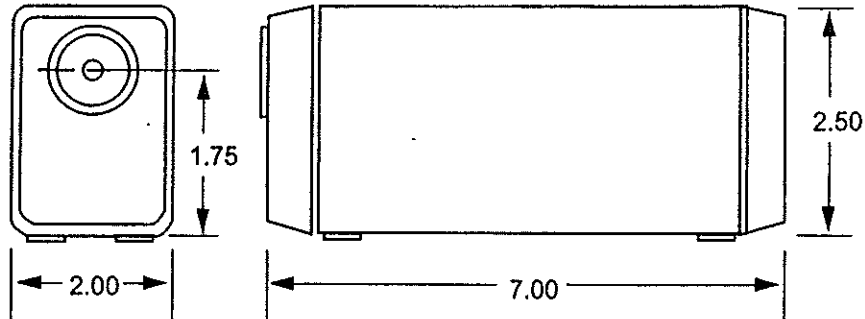

'T' SLOT MOUNTING

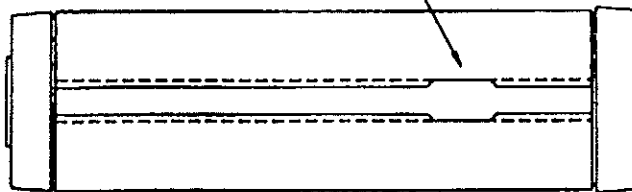

1500 Series Energizer

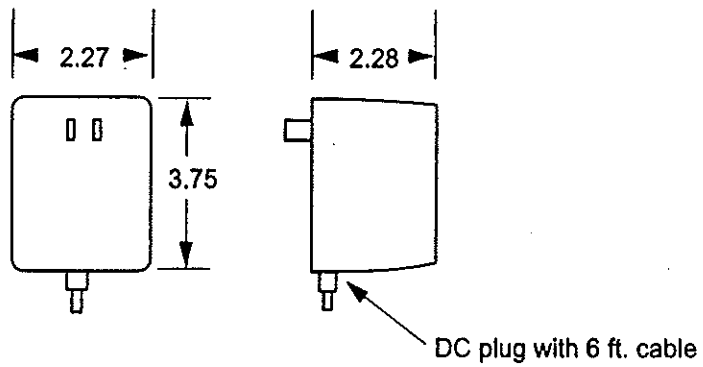

Operation and Maintenance

Initial Procedure

Before plugging in the power cord, make sure that the key switch on the power supply is in the "OFF" position and that the remote control is plugged in. The power cord receptacle must be grounded to the user's facility. Plug in the two-pronged high voltage cable from the laser head.

Plug in the power cord. Turn the key switch to "ON." The pilot light (radiation emission indicator) should light immediately and after a three-second delay (required by FDA/CDRH), the laser should ignite. Emission from the laser head will only be visible if the shutter (beam attenuator) is in the open position.

Note that if the remote control is not plugged in, the power supply will not activate; but the pilot light will still come on.

Power supplies are not interchangeable between models and should be connected only to the appropriate laser head model as specified in the Model Selection Table.

Troubleshooting

If the laser fails to turn on after following the initial procedure, turn the key switch to "OFF." Unplug the power high voltage cable. **EXERCISE CAUTION**, as the top cover is removed from the power supply. This top is held by two screws fed through the bottom. A residual **HIGH VOLTAGE** can exist on the cables leading from the potted module to the high voltage receptacle shortly after the supply is turned off. These cables are normally completely insulated. Check the fuse in back of the front panel. If the fuse is open, replace it with an identical fuse and follow the initial procedure once again. Should the system function normally thereafter, the problem was probably caused by a line transient.

If the fuse continues to open, there may be a malfunction within the power supply module. If no shorts are found in the power supply, return both the power supply and laser head to Uniphase in accordance with the warranty policy.

If, after following the initial procedure, the laser output is not present or is intermittent, check to make sure the input AC line voltage is within required limits and the high voltage connection between laser head and power supply is properly mated. *Under no circumstances should any attempt be made to dismantle the laser head.* If the problem remains, return both the power supply and laser head to Uniphase in accordance with the warranty policy.